

Martinez Refining Company

Regulation 12 Rule 12

FLARE MINIMIZATION PLAN

PUBLIC VERSION

Updated October 1, 2021

Submitted to:

Bay Area Air Quality Management District
375 Beale Street Suite 600
San Francisco, California 94105



CERTIFICATION

I certify that based on the information available to me the 2021 Annual Update of Martinez Refining Company's Flare Minimization Plan dated October 1, 2021 is accurate, true and complete.



Gordon Johnson
Environmental Manager
Martinez Refining Company

Date

FLARE MINIMIZATION PLAN
MARTINEZ REFINING COMPANY

Table of Contents

1.0	EXECUTIVE SUMMARY	1-1
2.0	INTRODUCTION	2-1
A.	REFINERY AND FLARE SYSTEM GENERAL OVERVIEW	2-1
3.0	PREVENTION MEASURES COMMON TO ALL PROCESS FLARES	3-1
A.	COMMON PREVENTION MEASURES – POLICY, PROCEDURES AND OTHER RESOURCES TO MINIMIZE FLARING	3-1
B.	COMMON PREVENTION MEASURES - PROCESS EQUIPMENT AND HARDWARE TO MINIMIZE FLARING.....	3-5
4.0	INFORMATION FOR INDIVIDUAL FLARE SYSTEMS	4-1
A.	FLARE SYSTEM: LIGHT OIL PROCESSING (LOP) FLARE	4-1
I.	SYSTEM DESCRIPTION (12-12-401.1)	4-1
II.	HISTORICAL FLARING REVIEW	4-4
III.	REDUCTIONS PREVIOUSLY REALIZED (12-12-401.2).....	4-17
IV.	PLANNED REDUCTIONS (12-12-401.3).....	4-21
V.	PREVENTION MEASURES (12-12-401.4).....	4-21
B.	FLARE SYSTEM: DELAYED COKING AREA FLARE	4-30
I.	SYSTEM DESCRIPTION (12-12-401.1)	4-30
II.	HISTORICAL FLARING REVIEW	4-32
III.	REDUCTIONS PREVIOUSLY REALIZED (12-12-401.2).....	4-43
IV.	PLANNED REDUCTIONS (12-12-401.3).....	4-46
V.	PREVENTION MEASURES (12-12-401.4).....	4-47
C.	FLARE SYSTEM: OPCEN HYDROCARBON FLARE.....	4-52
I.	SYSTEM DESCRIPTION (12-12-401.1)	4-52
II.	HISTORICAL FLARING REVIEW	4-54
III.	REDUCTIONS PREVIOUSLY REALIZED (12-12-401.2).....	4-61
IV.	PLANNED REDUCTIONS (12-12-401.3).....	4-62
V.	PREVENTION MEASURES (12-12-401.4).....	4-62
D.	FLARE SYSTEM: OPCEN FLEXIGAS FLARE	4-64
I.	SYSTEM DESCRIPTION (12-12-401.1)	4-64
II.	HISTORICAL FLARING REVIEW	4-67
III.	REDUCTIONS PREVIOUSLY REALIZED (12-12-401.2).....	4-75
IV.	PLANNED REDUCTIONS (12-12-401.3).....	4-81

V. PREVENTION MEASURES (12-12-401.4)..... 4-81

5.0 APPENDICES (12-12-401.1)

- A. LOP AREA FLARE TECHNICAL DATA
- B. DELAYED COKING AREA FLARE TECHNICAL DATA
- C. OPCEN HYDROCARBON FLARE TECHNICAL DATA
- D. FLEXIGAS FLARE TECHNICAL DATA
- E. REFINERY FUEL GAS SYSTEM
- F. DETAILED ECONOMICS FOR FLARE MITIGATION OPTIONS

LIST OF FIGURES

- ES-1. Flare Flow – Total Annual Flare Flow LOP, DCU, OPCEN HC Flares 2004 – 2021 YTD
- ES-2. Flare Flow – Annualized Flexigas Flow 2004- 2021 YTD
- ES-3. Combined Flare Emissions – All Flares 2004 – 2021 YTD

1. LOP Area Flare Simplified Process Sketch
2. LOP Area Flare Events (2000 – 2005)
3. LOP Flare Gas Volumes (2005)
4. LOP Flare Gas Flow Rates (2005)
5. LOP Flare Durations (2005 – 25 Events)
6. Sketch of Options for LOP Area Flare
7. Delayed Coking Area Flare Process Sketch
8. Delayed Coking Area Flare Events (2000 – 2005)
9. Delayed Coking Area Flare Volumes (2005)
10. Delayed Coking Area Flare Gas Flow Rates (2005)
11. Delayed Coking Area Flare Event Durations (2005)
12. OPCEN Hydrocarbon Flare Area Process Sketch
13. OPCEN Hydrocarbon Flare Gas Volumes (2005)
14. Flexigas Supply System and Flare Process Sketch
15. Flexigas Area Flare Events (2005)
16. Flexigas Flare Gas Volumes (2005)
17. Flexigas Flare Process Sketch Option 1
18. Flexigas Flare Process Sketch Option 2A
19. Flexigas Flare Process Sketch Option 2B

FIGURES ADDED IN SUBSEQUENT UPDATES

- 2006-1 OPCEN HC Flare Monthly Flare Flows – 1/1/04-7/1/21
- 2008-1 LOP Flare Events with Causal Analysis vs. Small Events (1/1/06-6/1/08)
- 2008-2 DCU Flare Events with Causal Analysis vs. Small Events (1/1/06-6/1/08)
- 2008-3 Probable Causes of DCU Flaring 1/1/06 – 6/1/08
- 2008-4 Probable Causes of OPCEN HC Flaring 1/1/06 – 6/1/08
- 2008-5 Flexigas Flare Flows 1/1/06 – 6/1/08

LIST OF TABLES

1. Economic Justification for Additional Recovery Capacity at LOP Flare
2. Economic Justification for Additional Recovery Capacity at DC Flare
3. Economic Justification for Addition of Flexigas Consumer
4. Economic Justification for Recovery of Flexigas

1.0 EXECUTIVE SUMMARY

This Flare Minimization Plan is provided pursuant to the requirements of Bay Area Air Quality Management District (BAAQMD) Regulation 12 Rule 12, Title 40 of the Code of Federal Regulations (CFR) Part 60, Subpart Ja and 40 CFR Part 63, Subpart CC. This Plan provides for continuous improvement in emission reductions from flares at the Martinez Refining Company (MRC). These flares are essential refinery safety equipment that provide a means to safely and efficiently control gases that would otherwise be released to the environment.

This annual update of MRC's Flare Minimization Plan (FMP) covers flaring that occurred during the period from July 1, 2020 through June 30, 2021 in addition to the historical data included in the original plan and previous annual updates. This document updates the flare technical data as needed and the planned reductions and prevention measures identified as a result of Causal Analyses conducted during the time period of this update.

Figure ES-1 presents the total annual vent gas flow to the Light Oil Processing (LOP), Operations Central Hydrocarbon (OPCEN HC) and Delayed Coking Unit (DCU) Flares at the refinery from 2004 through June 30, 2021. Flare flow continues to be very low.

FIGURE ES-1

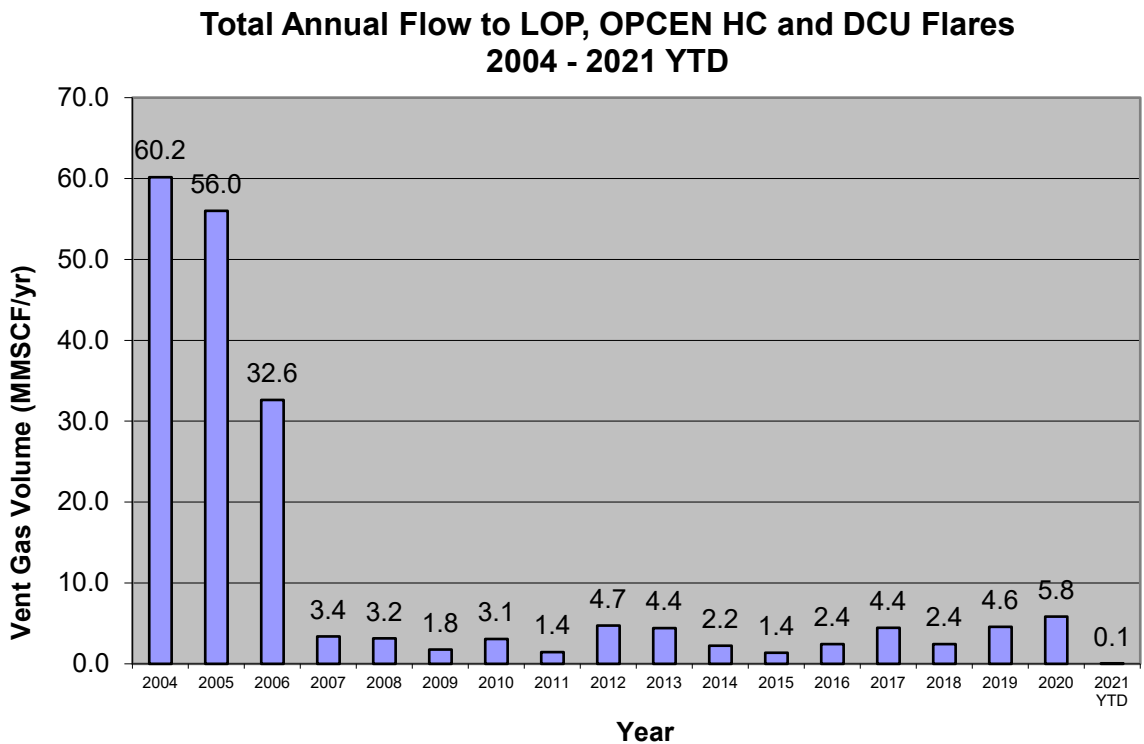

Figure ES-2 shows the annualized vent gas flow from the Flexigas Flare. This figure shows a cyclic increase in Flexigas flaring which occurs during years with startup and shutdown of the Flexicoker due to the nature of the Flexicoking and Flexsorb processes. The flaring of treated flexigas during startups and shutdowns of the Flexicoker is allowed up to specified limits in MRC's Title V permit. Flexigas is a very low BTU gas used as a supplemental refinery fuel gas in refinery process heaters. Flexigas is treated for sulfur removal in the Flexsorb Unit before being combusted either in refinery process heaters or if necessary, in the Flexigas Flare. When FXG is flared, the volume of gas is typically large compared to the volume flared in the other refinery process flares, but emissions are significantly less because Flexigas contains very low concentrations of non-methane hydrocarbon and sulfur.

Flexigas flaring can also occur due to refinery fuel gas imbalance. MRC continues to fine-tune the Flexigas pressure control scheme to minimize flexigas flaring due to small imbalances in fuel gas. Improvements in this system, most notably addition of COGEN to the pressure control scheme, contribute to the very low flexigas flare flow rate seen in non-turnaround years including 2013, 2014, 2015, 2017, 2018, and 2020.

FIGURE ES-2

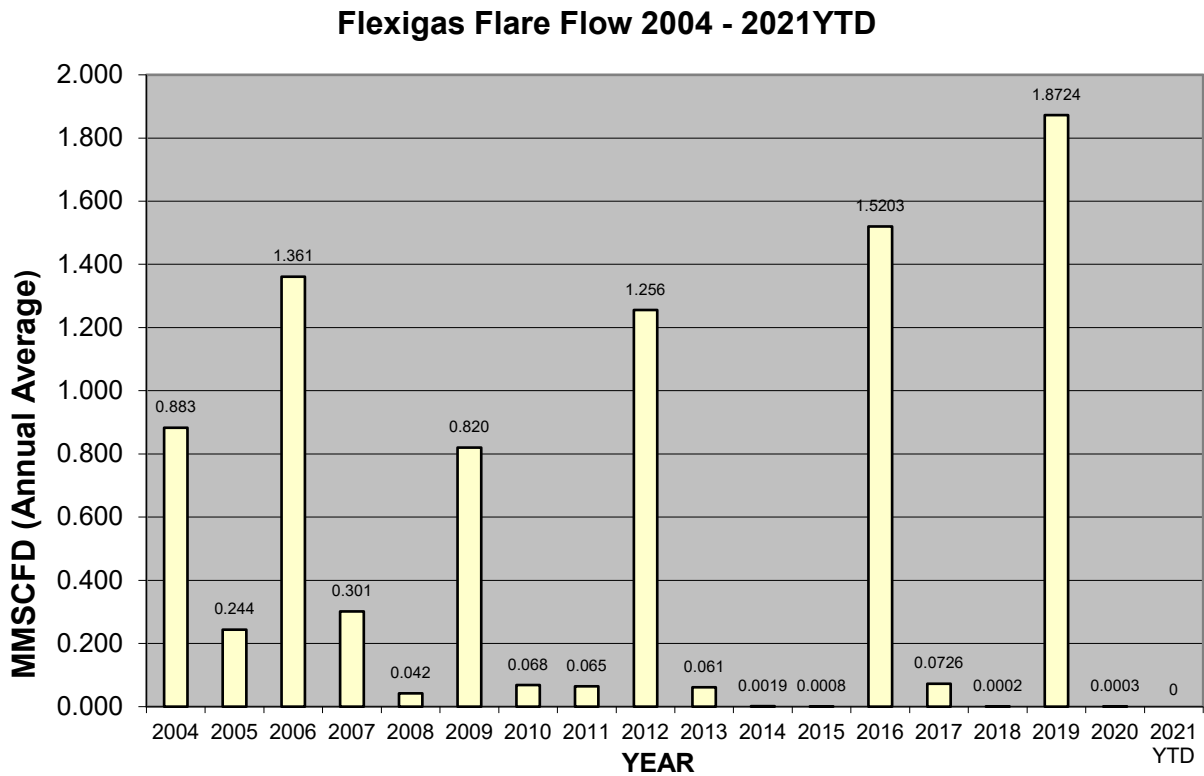

Figure ES-3 shows the methane, non-methane hydrocarbon, and sulfur dioxide emissions from all four refinery process flares from 2004 through June 30 of this year.

FIGURE ES-3

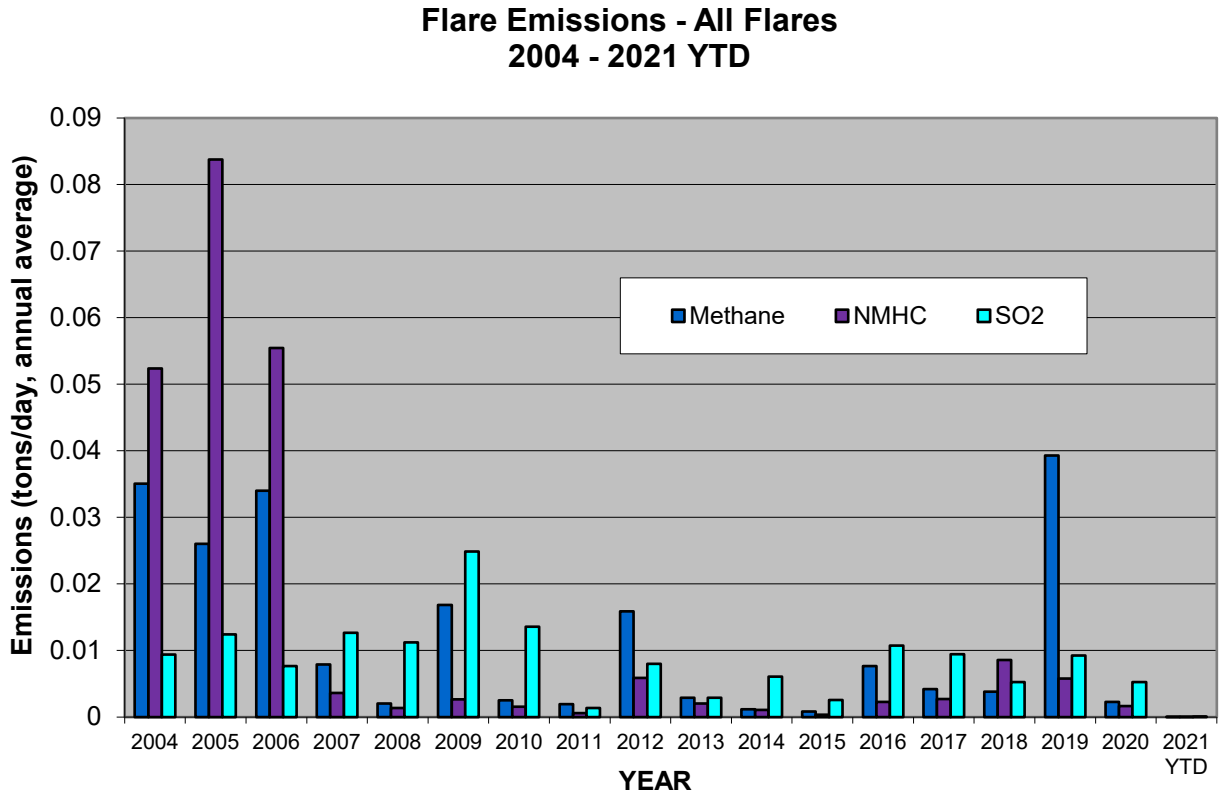

Figure ES-3 shows the significant reduction in emissions that has occurred since the implementation of the Flare Minimization Plan in 2006 and highlights that even with large volumes of flexigas flaring during turnaround years, overall emissions from flaring are low.

During the time period covered by this update, there was only one flaring event triggering a Causal Analysis investigation for flaring greater than 0.5 MMSCF or 500 lbs of SO₂. The one event occurred at the LOP flare on July 8, 2020 when the compressor in the Saturates Gas Plant (SGP) tripped off.

The flaring event was managed per our flare procedures to minimize the amount of flaring and were in compliance with the requirements of BAAQMD Regulation 12 Rules 11 and 12 and MRC's Flare Minimization Plan. The results from the investigation into the event was reported to the District in a Causal Analysis report. Prevention measures were identified and implemented. Additional information can be found in the flare specific sections of this FMP.

MRC expects continuous improvement and reductions in flaring as MRC continues to investigate flaring events and implement prevention measures to minimize or prevent re-occurrence. Non-methane hydrocarbon (VOC) emissions have been reduced from a high of over 30 tons per year in 2005 to 0.6 tons in 2020. All flaring, whenever it occurs, is minimized and stopped as quickly as possible. Keep in mind however, that one flaring event can significantly affect the annual totals. Above all else, flares are essential refinery safety equipment. They provide a means to ensure the safe and efficient combustion of gases that would otherwise be released to the environment.

Every flaring event results in continuous improvement in our efforts for flare minimization. MRC's FMP evaluates several options for additional capital equipment and modifications to operating procedures to further reduce the volume of gas flared. As the refinery already has very significant capital infrastructure for flare gas recovery in place, procedural modifications typically achieve more cost-effective reductions. Refinery procedures described in this Flare Minimization Plan address actions to further minimize flaring during process upsets and additional planning requirements for maintenance and turnaround activities. Careful planning of any activity with the potential for flaring is the most successful minimization approach that has been employed at MRC. Procedures for reporting and investigating all flaring provide a means to learn from unanticipated events.

2.0 INTRODUCTION

MRC's Flare Minimization Plan (FMP) is written to comply with the requirements of the Bay Area Air Quality Management District's Regulation 12 Rule 12 and Title 40 of the Code of Federal Regulations (CFR) Part 60, Subpart Ja and 40 CFR Part 63, Subpart CC. This Plan provides for continuous improvement in emission reductions from flares at MRC's Martinez refinery. The original FMP approved in July 2007 described prevention measures that had been implemented over the previous five years, presented prevention measures for consideration and described those that would be implemented to minimize flaring to the extent possible without compromising safety.

Flares are essential refinery safety equipment. They provide a means to ensure the safe and efficient combustion of gases that would otherwise be released to the environment.

The MRC has four process flares subject to Regulation 12 Rule 12 and Title 40 of the Code of Federal Regulations (CFR) Part 60, Subpart Ja and 40 CFR Part 63, Subpart CC. These flares are called:

- Light Oil Processing (LOP) Flare (BAAQMD Source # 1471),
- Delayed Coking Unit (DCU) Flare (Source # 4201),
- Operations Central (OPCEN) Hydrocarbon (HC) Flare (Source # 1772)
- Flexigas (FXG) Flare (Source # 1771)

These flares each serve specific processing units in the refinery and because they were constructed at different times and for different process units, each flare system is somewhat different.

MRC's four process flare systems are described in detail in this FMP. There are common Prevention Measures that are in place which help to reduce flaring at all four flares. These common Prevention Measures are described in the section titled Prevention Measures Common to All Process Flares. Following this section, each flare system is described individually providing technical data, flare reductions previously implemented, planned reductions and specific Prevention Measures for each flare. Historical flaring data was reviewed for each flare system and information from this review used to determine the feasibility of reducing flaring in the future by examining cost and benefits of potential equipment modifications.

A. REFINERY AND FLARE SYSTEM GENERAL OVERVIEW

MRC refines crude oil into gasoline, diesel fuel, jet fuel, coke and liquefied petroleum gases (propane, butane and pentane). As part of the refining process, gases are produced that are typically routed to treaters to remove sulfur compounds and then routed to the refinery fuel gas system for use as fuel in refinery heaters and boilers. Natural gas is purchased to meet additional fuel requirements. MRC is designed and operated to balance fuel gas production with consumption. Natural gas is used to help keep the system in balance.

Each flare system at MRC has a header for collecting vapor streams from the process units it serves. The primary function of the flare header is to provide the process units with a controlled low-pressure outlet for gases. Many of the processes operate at elevated temperatures and pressures and a critical element of safe design is the capability of releasing excess pressure in a controlled manner to the flare when necessary for safe operation. Flares are the safety devices that allow this to happen and MRC will use the flare when necessary for safe operation of the refinery. Flare use must be unrestricted for emergencies from any cause and to prevent accidents, hazards or release

of vent gas directly to the atmosphere. Any flaring considered at any time to be necessary for the safe operation of the refinery must be allowed.

Two of MRC's flare systems (LOP and DCU) were constructed with vapor recovery to recover the gases in the flare header for use as a fuel. A project was implemented in late 2006 to provide vapor recovery for the OPCEN HC flare. The Flexigas Flare is unique, and flare gas recovery on this flare is infeasible as will be discussed further in the FMP.

Flares are designed to promote good combustion over a broad range of gas flow rates and compositions. Flares have pilots that are kept burning at all times with natural gas to ensure that any gases that get to the tip of the flare are ignited for proper combustion. Flare headers must be purged to keep air out. Purge gas (typically nitrogen) is provided to prevent oxygen intrusion from the flare stack into flare headers at LOP, DCU and OPCEN Hydrocarbon flares. A minimum flow of Flexigas is used to prevent air intrusion at the Flexigas flare. Without these purges, oxygen can combine with hydrocarbon gas and cause combustion or detonation within the flare header. MRC flare systems each comply with the BAAQMD Regulation 12 Rule 11 Flare Monitoring requirements and the EPA requirements found in 40 CFR 63.670. Ultrasonic flare flow meters and automatic sampling systems along with BTU analyzers as needed to measure the BTU of the flare gas are in place to monitor and collect flare data. Video cameras are located at each flare to provide the ability to monitor the operation of each flare in the control room.

3.0 PREVENTION MEASURES COMMON TO ALL PROCESS FLARES

This section describes measures implemented to minimize flaring that are common to all of MRC's process flare systems¹. Measures include policy and procedural activities, as well as process and hardware measures. Additional prevention measures for specific flare systems are provided in sections specific for each flare.

A. COMMON PREVENTION MEASURES – POLICY, PROCEDURES AND OTHER RESOURCES TO MINIMIZE FLARING

Policy: The purpose of the four process flares serving the MRC Martinez refinery is to assure that process unit vent gases are safely burned to minimize the potential for explosion, fire, or other unsafe conditions. The refinery will not flare above the minimum amount necessary to assure the safety of our workers and nearby community, and provide for reliable operation of process equipment. MRC will adjust the operation of process units to minimize flaring when consistent with safe and reliable operation.

Procedures:

MRC believes that the key to flare minimization is careful planning to avoid flaring coupled with evaluation of any flaring events that do occur and incorporation of lessons learned back into the planning process to further reduce flaring. Four refinery procedures were developed or revised as part of the FMP to implement this process. When these procedures are followed, any flaring is consistent with the FMP.

In no case do any of these procedures limit access to flares when such use is viewed necessary for personnel or equipment safety. MRC supports operator judgment in the use of the flares without hesitation where warranted for safety.

Following is a list of procedures describing flare use covered by the Flare Minimization Plan.

- Environmental Procedure 2.20: Environmental Procedure stating the Refinery Flaring Policy, describing the FMP and regulatory requirements for various categories of flaring, and defining document requirements and retention
- Administrative Requirements and Management Systems for General Operations C(F)20: Flaring Due to Process Upsets or Unanticipated Equipment Failure
- Administrative Requirements and Management Systems for General Operations C(F)21: Flaring Due to Unit Startup, Unit Shutdown, Major Maintenance or Turnaround Activities
- Administrative Requirements and Management Systems for General Operations C(F)22: Fuel System Management during Flare Events

¹ These prevention measures address requirements of section 12-12-401.4 and 63.670(o)(1)(ii).

Summary Description of Procedures

1. REFINERY FLARE MANAGEMENT AND REPORTING – EP 2.20

This procedure describes the MRC Martinez refinery policy to minimize flaring from process flares serving Light Oil Processing, OPCEN, and Delayed Coking. When flaring occurs, it is subject to this procedure. In addition to stating this policy, this procedure includes the following:

- Requirements necessary to comply with BAAQMD Regulation 12 Rule 11 - Flare Monitoring at Petroleum Refineries, Regulation 12 Rule 12 – Flares at Petroleum Refineries, MRC Title V permit requirements regarding flaring, EPA requirements regarding flaring and the refinery Flare Minimization Plan
- Responsibilities of all groups and departments in the refinery with respect to flare management and reporting. Responsibilities are described for operations, maintenance, process engineering, control systems, quality assurance lab and environmental affairs
- A description of the related Field Requirements Manual operating procedures, C(F)20, C(F)21 and C(F)22, defining when they are triggered and who is responsible for implementation
- Recordkeeping and document control

2. FLARING DUE TO PROCESS UPSETS OR EQUIPMENT FAILURE - C(F)20

This procedure addresses flare events caused by process upsets, unplanned events or equipment and instrument failures that result in flaring. Any flaring that is not planned is covered by and must comply with this procedure.

By nature, the causes and options available to mitigate flaring due to upsets, unplanned events or unanticipated equipment failure, are unique. As a result, procedures to minimize specific events cannot reasonably be predefined in the plan. This procedure describes in general terms the nature and priority of actions to minimize flaring in the event of a process upset, unplanned event or equipment failure. It references the overarching Environmental Procedure and reiterates the policy to minimize flaring where this may safely be done. The Procedure requires the following:

- All flare activity must be reported to the Refinery Team Leader (RTL) and Environmental Affairs. This includes the likely source and probable cause of the flaring.
- After a flaring event (defined as greater than 0.5 MMSCFD flared), an incident investigation and/or causal analysis will be conducted and documented.
- Actions taken to minimize flaring will be captured when personnel and process safety allow. The RTL is responsible to assure this activity has been resourced.

Following any flaring, information will be compiled and retained to show that the flaring was minimized. The compiled information includes:

- Description of the flaring event and any consideration or measures taken to reduce flaring during the event
- For flaring greater than 0.5 MMSCF, the incident investigation/causal analyses
- For flaring less than 0.5 MMSCF, a description of any lessons learned
- Management activity to assure lessons learned and recommendations from the causal analysis will be compiled, retained and incorporated into future FMP updates

3. FLARING DUE TO PLANNED START UP, SHUTDOWN, MAJOR MAINTENANCE OR TURNAROUND – C(F)21

Because each turnaround is unique, it is impractical to develop specific flare mitigation plans for all turnarounds in advance. Instead, this procedure requires a specific plan in advance of each planned turnaround or major maintenance activity that includes a review of potential flaring and evaluation of possible mitigations to minimize any flaring. Steps taken to minimize flaring in the event that deviations from the plan are necessary would be included in the plan to the extent they can be anticipated.

This procedure represents an extension and formalization of the historical practice where environmental impacts are assessed, communicated, and managed. Specific plans will assure the potential for flaring during major maintenance, turnaround and startup and shutdown activities has been considered and all feasible steps taken to minimize flaring – including consideration of the impact of the activity on fuel balance.

The procedure requires that the Operating Department and Turnaround groups develop plans with input from the Planning Group and Environmental Affairs. Status and expected impacts are shared across the refinery. The overall environmental performance is reviewed after the turnaround to develop “lessons learned” for subsequent turnarounds.

If unanticipated flaring occurs during any part of a turnaround, then Procedure C(F)20 is triggered to ensure that lessons learned and recommendations to minimize flaring from this activity in the future are captured.

4. FUEL SYSTEM MANAGEMENT DURING FLARING EVENTS – C(F)22

This procedure comprises a “Best Practice” for fuel system management in the event of flaring for any reason that impacts the fuel gas system balance. The procedure describes actions that should be taken as soon as it is safe to minimize flaring if it occurs due to a fuel gas system imbalance. The procedure requires that the actions taken be documented once the condition that resulted in flaring is under control. The documentation is made in the refinery’s environmental incident tracking database (or its successor) and is made available to the District upon their request. The documentation addresses:

- Alternatives considered
- Constraints encountered which caused flaring to continue after the original condition that caused the flaring no longer exists

The documentation required by this procedure is directed as follows:

- Where the fuel gas imbalance results from planned maintenance, documentation will be included with the Startup/Shutdown/Major Maintenance documentation
- Where the imbalance is caused by process upset, unanticipated events that result in flaring or equipment failure, documentation will be included with the Process Upset documentation

Other Resources

WORK PROCESSES: Complimenting our flare procedures, a variety of work processes combine to effectively minimize potential flaring. These work processes are continually evolving and may

not produce a documented record. They are mentioned to provide a perspective of how the refinery communicates to optimize refinery operations and minimize flaring.

System Teams: Several work groups, known as System Teams, work to minimize potential flaring by discussing volatiles (propane, butane, pentane) management and fuel balance for planned events and long-term strategy. In the event of unplanned events, these same teams work to minimize the magnitude and duration of flaring.

On-Shift Leadership: The Refinery Team Leader provides 24-hour coverage to integrate and manage operational events that may cause flaring. This position, supported by additional staff on and off-shift, provides the capability to intercept and deflect events that may otherwise cascade through process units in various parts of the plant. This work involves developing, coordinating and implementing plans to mitigate unexpected flaring.

Refinery Reliability and Maintenance Programs: The MRC Martinez Refinery utilizes several key work processes to keep our equipment and processes operating reliably. Reliable equipment and process operation minimizes flaring due to upset or unanticipated events including pressure releases to the flare system. Preventative maintenance is the key technique to reduce the probability of equipment failure.

All flare gas recovery compressors in the refinery are normally running. Compressors are purposefully removed from service only when monitoring of the machine or its associated equipment indicates the need for maintenance or a more elaborate inspection that requires a shutdown. The need to remove compressors from service for maintenance is based on regular evaluation of the machine's condition such as vibration. This Performance or Risk-based approach has generally replaced specified maintenance intervals.

MRC global standards known as the Global Asset Management Excellence processes were specifically designed to improve reliability of all equipment which in turn reduces flaring due to equipment failure, process upset, pressure relief device releases, etc. The processes include:

- **Maintenance Execution:** This process covers the day-to-day execution of maintenance work including screening, assessment, planning, scheduling, execution and review of the maintenance work to optimize the reliability and availability of the assets.
- **Reliability Centered Maintenance (RCM):** RCM is the systematic improvement of equipment care through analysis of failure modes to identify optimum operator surveillance and planned maintenance tasks.
- **Ensure Safe Production (ESP):** The Ensure Safe Production (ESP) work process was developed by MRC to map, establish metrics and implement a suite of work processes designed to deliver superior results in the area of Process Safety Management. The overall objective is to substantially increase reliability by ensuring operation of facilities in a safe, environmentally sound and productive manner. In implementing the ESP work process, safe limits of operation are established, communicated, and maintained. The objective is to ensure operation within defined limits at all times.
- **Instrument Protective Functions (IPF):** An instrumented function whose purpose is to prevent or mitigate a hazardous situation. An IPF is intended to achieve or maintain a safe state for the process in the event of a specific hazardous event. IPFs are frequently referred to as emergency shutdowns, protective instrument systems, safety trips, or interlocks. They bring a process or piece of process equipment to a safe condition in the event of a failure or an abnormal operating condition. In order for these systems to mitigate the risks

for which they were designed, they must be as reliable as possible. For this reason, strict guidelines and procedures are followed to ensure their protection is not compromised.

- **Equipment Integrity:** – this process aims at an active reduction of unforeseen events by setting the boundaries of the Integrity Operating Windows to more accurately predict equipment life.
- **Turnarounds:** The objective of the turnaround process is to restore the plant to a physical state appropriate to meet its expected run length within the boundaries of our standards and regulatory requirements while optimizing plant delivery to meet production plans.

B. COMMON PREVENTION MEASURES - PROCESS EQUIPMENT AND HARDWARE TO MINIMIZE FLARING

Key to preventing flaring is reliable access to process and hardware to either avoid creating or effectively manage any excess of treated or untreated gas. The MRC refinery has several features that provide a high degree of flexibility in this area. These features are described below, and additional details are provided in Appendix E.

- **Fuel System Control:** A robust refinery fuel system is required in order to minimize flaring. The Martinez Refinery has two independent fuel systems: the refinery fuel gas system (RFG) and the Flexigas system (FXG). These fuels have separate distribution systems comprised of independent piping and separate burners. The two fuels are never directly combined. The separate fuel systems provide fuel to many of the same heaters. To maintain a constant heater duty, some amount of FXG can be removed from a heater to allow an increase in the amount of RFG to that heater.

There is only one refinery fuel gas blend drum that blends the gases that comprise the RFG fuel system. These gases include treated vent gases from various process units, propane, butane and purchased natural gas. The Flexigas fuel system is made up only of treated Flexigas and so there is no blending and no blend drum.

A few of the factors contributing to the robustness of the combined fuel gas systems are listed below.

- **Pressure Control:** The capability to pressure-control the RFG system with purchased natural gas, own-produced fuel gas and propane streams helps reduce flaring, which may otherwise result from dynamic variations of non-elective fuel contributors. Fuel system supply pressure must be maintained steady for reliable operation of fired heaters. This stable operation is complicated by the nature of many of the flows that contribute to the fuel gas system. Having a range of streams available to provide pressure control minimizes the risk of fuel system pressures rising above target, which would otherwise result in flaring.
- **Heating Value and Specific Gravity:** The refinery fuel gas system is monitored for specific gravity and BTU content. BTU content and gravity of blended refinery fuel gas are maintained in an acceptable range by adjusting purchased natural gas and moving individual component streams between the hydrogen plant feed system and fuel system. Specific Gravity is maintained between 0.5 and 0.83. The monitoring and adjustment helps maintain the stability of fired heaters and allows major heaters to anticipate changes in raw fuel composition that would be required for stable operation of the process unit. The resulting flexibility is sufficient to prevent the need to flare individual fuel component streams, or recovered flare gas, due to their impact on blended fuel gravity or BTU value.

Flexigas is produced by gasifying coke produced in the Flexicoker. The nature of the gasification reaction assures the composition and BTU content of Flexigas are extremely stable. Gasifier temperature is monitored to assure the BTU content of Flexigas is acceptable to be routed to process heaters.

- **Sulfur Content:** H₂S content of both fuel gas systems is monitored to ensure they meet all regulatory requirements. Alarms are set to provide early warning of H₂S concentration changes which allow the cause to be identified and mitigated to avoid violation of the H₂S limits.

A variety of sulfur specifications are applicable to process heaters at the refinery. Details of these specifications are available in MRC's Title V permit. The H₂S content of both blended RFG from the fuel gas blend drum and Flexigas is measured using on-line analyzers to assure compliance with applicable regulatory limits for consumers in LOP and OPCEN. Sulfur limits for process heaters constructed as part of the Clean Fuels Permit are generally lower than for the rest of the refinery and include other sulfur species (see Title V permit for the limits). Analyzers continuously monitor sulfur species (H₂S and total reduced sulfur) in fuel gas routed to Clean Fuels units.

The Martinez Refinery does not flare untreated fuel component streams in either fuel gas system to avoid an exceedance of a sulfur limit.

- **Stability.** The number and size of process units at MRC provide a significant fuel demand even during large process unit turnarounds. Planned turnaround activity can usually be managed to leave enough of the fuel system in operation to absorb recovered vents generated during equipment depressuring and startup and shutdown activities. The combination of process units comprising a maintenance turnaround block takes into consideration the need for fuel demand for these gases. When it is not possible to completely avoid an excess of fuel, the sequence of startups and shutdowns is evaluated to minimize the duration and volume of flared gases.
- **Cogeneration Plant:** The refinery Cogeneration unit has the ability to use fuel streams that may otherwise be flared to produce steam and electricity.
- **Railcar Loading of Excess Volatiles:** During periods where there is an excess of fuel suppliers over fuel consumers, reducing the amount of volatile liquids such as propane and butane in the fuel system minimizes the potential for flaring due to fuel gas imbalance. MRC has extensive ability to load volatile liquids for sale rather than route them to the fuel system. The refinery has an automated propane truck rack as well as the ability to load railroad tank cars with volatile liquids. The ability to ship volatile liquid products out by both truck and rail provides significant flexibility in the fuel gas system and results in the reduction of flaring that would otherwise be necessary during some fuel gas imbalance situations.
- **Wet Gas Compressor Modifications:** Major refinery conversion units (Cat Cracker, Delayed Coker, and Flexicoker) have wet gas compressors to route a gas stream containing volatile liquids (wet gas) to a gas plant for treating to remove condensable liquids and sulfur components. At MRC, hardware has been provided to assure wet gas compressors are available to recover gases to route to the fuel system without flaring during unit startup. These large compressors generally cannot operate reliably without adequate gas flow through the machine. To avoid operation without adequate gas flow, all wet gas compressors at the refinery are provided with recycle spill-back hardware to control surge and reduce potential flaring. These facilities include piping and control valves that allow the discharge gas to return to the machine suction. By this method, the compressor has sufficient gas flow through the machine to prevent surge, even when the net gas production from the upstream conversion reaction may be low, for example during startups and shutdowns. If these recycle facilities

were not available (e.g., because of a breakdown failure), it would be necessary to flare the gas until the conversion reaction provided the required minimum gas flow. This is a significant improvement from the original designs that generally called for flaring wet gas during startup until process unit operation had fully stabilized.

4.0 INFORMATION FOR INDIVIDUAL FLARE SYSTEMS

A. FLARE SYSTEM: LIGHT OIL PROCESSING (LOP) FLARE

BAAQMD Source No. 1471 /1472

I. SYSTEM DESCRIPTION (12-12-401.1)

The LOP Flare system is comprised of collection headers, liquid knockout vessels, two flare vapor recovery compressors, piping to route recovered gas to fuel gas treaters, a water seal vessel, the flare header proper, and the flare stack. The LOP flare is an elevated, steam-assisted flare with nitrogen purge to prevent air intrusion. Piping and valves provide sufficient flexibility to operate in various configurations, allowing continuous and reliable operation during turnarounds, inspection and maintenance activities without flaring. Maintenance of the elevated flare (S#1471) is accomplished by putting an alternate flare in service. This alternate flare (Backup Can Flare, S#1472) is normally blinded and is only used when the elevated flare is out of service for inspection or repair. A sketch of the LOP Flare system is provided in Figure 1. Technical details of the system are provided in Appendix A².

The process units in the LOP Area that are served by the LOP flare system include the Crude Unit, Vacuum Flasher, Straightrun and Catalytic Hydrotreaters, the Catalytic and Saturates gas plants, the Fluid Catalytic Cracker, Hydrocracker, Alkylation, Catalytic Reformer, Sulfur Recovery Units 1 and 2, Hydrogen Plant 1 and various Utilities systems.

Capacity of the two LOP flare gas recovery compressors is approximately 3.2 million standard cubic feet per day (MMSCFD) each for a total of 6.4 MMSCFD. Typical flare header gas flow, in the absence of relief events or unusual operation, is around 2.5 MMSCFD – well within the capacity of one compressor to recover. This normal base flow in the header is typically from many small sources including instrument purges, pump and compressor seal purges, sample station venting, and pressure control for refinery equipment. Because the LOP flare recovery compressors are both normally in operation except during maintenance, there is typically about 4 MMSCFD reserve capacity above the base load available to recover unexpected flows resulting from relief events, or increased vent flows associated with planned and unplanned events. When one of the two compressors is out of service for maintenance, the compressor remaining in service is able to recover the routine flare header flow.

The ability to take one compressor out of service for routine maintenance without flaring provides the ability for sufficient maintenance to ensure reliable compressor operation. Only one of the two compressors is scheduled for planned maintenance at any one time. Typical preventative maintenance involves a 'minor' (process-side) overhaul or a 'major' (process-side + running gear) overhaul. A process-side overhaul typically includes: replacing suction and discharge valves; overhauling suction valve unloaders; replacing piston rod packing; replacing piston rings and rider bands; and inspecting piston rods and cylinder liners. A running gear overhaul typically includes: inspecting crossheads and connecting rods; replacing connecting rod bushings and bearings; inspecting crankshaft and main bearings; cleaning lube oil system; and miscellaneous work on instrumentation and auxiliary equipment.

¹ Information in this appendix meets requirements of section 12-12-401.1 and 40 CFR 63.670(o)(1).

As discussed in Section 3, MRC's maintenance program utilizes a condition-based approach to balance the frequency for preventative maintenance of a flare compressor to ensure reliable operation with the risk of flaring due to operation with only one compressor while the other is being maintained. Past maintenance history and current condition are used to evaluate the risk of operation beyond 'typical' overhaul intervals. Compressor operation is monitored closely by both operations and maintenance to ensure the highest probability of reliable operation. Typical variables that are monitored are suction and discharge pressures and temperatures, process flow, lube oil pressure and temperature, and vibration.

Recovered flare gas is treated to remove hydrogen sulfide and condensable liquids. Treated gas is routed to the fuel gas system. The fuel gas treaters typically used for LOP recovered flare gas are located in the Catalytic Cracker Gas Plant (CGP). When this unit is unavailable for any reason, recovered gas may be routed to the Saturates Gas Plant (SGP). Sufficient capacity can be made available in both sets of treaters for the incremental flow up to the total capacity of both compressors of about 6.4 MMSCFD.

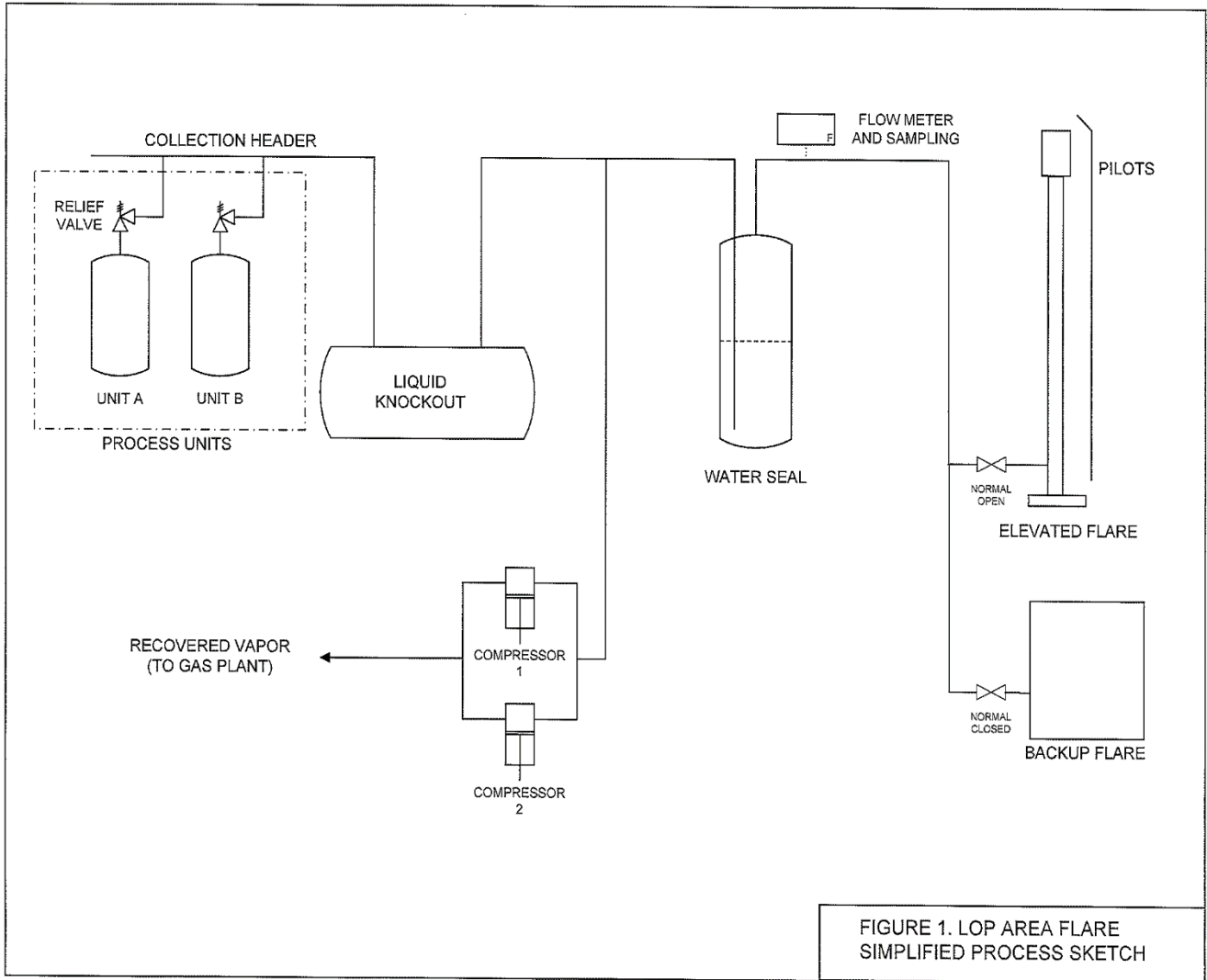

FIGURE 1. LOP AREA FLARE SIMPLIFIED PROCESS SKETCH

II. HISTORICAL FLARING REVIEW

Summary:

LOP flare activity 7/1/20-6/30/21

There was one LOP flaring event requiring Causal Analysis during the 12-month period of this update. On July 8, 2020 a compressor in the Saturates Gas Plant (SGP) tripped off resulting in flaring. The causal investigation determined that an air line associated with the compressor disconnected, resulting in the compressor to trip off. As a preventative measure, the air line was further isolated from other equipment to minimize the transfer of vibration to the line.

There were four other flaring events during the year at the LOP flare that did not trigger the need for a causal analysis. These events were not planned. The refinery works to respond quickly and safely to minimize flaring when it occurs. Every flaring event that occurs is reviewed and shared across the refinery for awareness.

LOP flare activity 7/1/19 – 6/30/20

There were six LOP flaring events requiring Causal Analysis during the 12-month period of this update. The first flaring even occurred on October 13, 2019 when a compressor in the Saturates Gas Plant (SGP) was not able to handle the increased load. The causal investigation determined that the compressor governor linkage was not correctly set to handle the higher loads. As a preventative measure, the installation and adjustment procedure was reviewed with staff.

The second LOP flaring event occurred on October 26, 2020 and was the result of lining up two compressors in the CRU at the same time while only one was being used. This line up caused back-flow into one of the compressors, resulting in the pressure exceeding a pressure safety valve set point and subsequent flaring. As a preventative measure, the procedure was updated to clarify that only one of the two compressors should be lined up at any one time.

On October 31, 2020, a low lube pressure reading caused a compressor in the Hydrocracker Unit (HCU) to trip off. Feed to the unit was stopped and the system safely depressurized to the LOP flare. As a preventative measure, the control associated with the lube oil was changed to increase stability of the system.

On January 16, 2020, a level indicator was incorrectly showing low level in a column in the SGP. This resulted in higher than expected levels in the column, causing backpressure at the column inlet and sending material to the flare. The cause was determined to be water entering the transmitter of the level indicator. The design was changed in a way that minimizes the opportunity for water entering the level transmitter.

An LOP flaring event happened on March 27, 2020 when the HCU compressor tripped, causing Hydrogen Plant 1 to trip offline. Eventually a second compressor associated with the hydrogen system failed, sending mostly hydrogen to the LOP flare. In addition, a check valve failed in an HCU vessel, resulting in additional material being sent to the flare. Components associated with the failed compressors were replaced and repaired.

On May 18, 2020, an electrical transformer failed and caused multiple units to shut down. As a result, material from the Catalytic Cracking Unit (CCU) was sent to the flare. A replacement transformer was installed and placed into service.

There were 19 small flaring events during the year at the LOP flare that did not trigger the need for a causal analysis. These events were not planned. The refinery works to respond quickly and safely to minimize flaring when it occurs. Every flaring event that occurs is reviewed and shared across the refinery for awareness. Corrective and preventative actions for the flaring are incorporated into guidelines and identified for training opportunities as appropriate.

LOP flare activity 7/1/18 – 6/30/19

There were two LOP flaring events requiring Causal Analysis during this period. The first flaring event occurred on July 8, 2018 when the overpressure control valve of the Catalytic Cracking Unit (CCU) main fractionator relieved to the LOP flare. The causal investigation identified that a setpoint for the air flow to a unit of the CCU was inadvertently set too low, causing the activation of a protective feed diversion. This resulted in flaring at LOP. After the investigation of this event, the control system was modified to prevent the system from accepting an air flow setting below the feed diversion trip point.

The second LOP flaring event occurred on June 7, 2019 when a pump leak and resulting fire caused the auto-depressurization of the hydrocracker unit (HCU) second stage system. The causal investigation determined that the seal chamber in a pump was worn as a result of metal debris collecting in the chamber. The sudden change in pressure from shutting down the pump may have then caused the seal to then break. This resulted in a leak of hydrocarbons that ignited. The fire triggered auto-depressurization to the LOP flare to safely stop the reaction and avoid a runaway condition. As a preventative measure, the pump will be changed to a design that will minimize the opportunity for debris to collect in the seal chamber, reducing the likelihood of debris impacting the seal integrity.

There were 9 small flaring events during the year at the LOP flare. None of the small events were planned. The refinery works very hard to respond quickly and minimize flaring when it occurs. Every flaring event that occurs is reviewed and shared across the refinery for awareness.

LOP flare activity 7/1/17 – 6/30/18

There were no flaring events requiring Causal Analysis on the LOP flare during this 12-month period. There were 23 small flaring events during the year on the LOP flare. None of the small events were planned and most lasted less than 10 minutes. The refinery works very hard to respond quickly and minimize flaring when it occurs. Every flaring event that occurs is reviewed and shared across the refinery for awareness. Corrective and preventative actions for the flaring are incorporated into guidelines, targets and identified for training opportunities as appropriate.

LOP flare activity 7/1/16 – 6/30/17

There were two flaring events requiring Causal Analysis on the LOP flare during this 12-month period. The first flaring event occurred on 12/19/16 when a partial power outage resulted in the shutdown of several process units and the second event occurred on 6/15/17 when a pressure control valve failed partially open resulting in excess fuel gas to the flare header. The causal investigation into the 12/19 power outage identified that a main electrical breaker tripped when the contacts on an auxiliary relay were manually closed during troubleshooting into the cause of an alarm by electrical staff. The investigation focused on the human interfacing and decision making

to determine the causes as to why the electrical staff manually interacted with the relay. As a result of the investigation, Prevention Measures are planned to improve the Electrical Job Safety Analysis template and to install additional informational labels on the relays and alarms in the substation.

The 6/15/17 flaring event that also triggered Causal Analysis was the result of the failure of the I/P transducer on a pressure control valve on the fuel gas blend drum that allowed the valve to fail partially open. Treated fuel gas leaked by the partially open valve into the flare recovery header and resulted in flaring. The source of the material leaking into the flare header was difficult to identify because the valve failure was intermittent. The failed transducer was replaced with a newer model and the flare header leak check guidelines are being evaluated to identify revisions that could improve the investigation process into a leak into the flare header.

There were 21 small flaring events during the year on the LOP flare. None of the small events were planned and most lasted only a few minutes. The refinery works very hard to respond quickly and minimize flaring when it occurs. Every flaring event that occurs is reviewed and shared across the refinery for awareness. Corrective and preventative actions for the flaring are incorporated into guidelines, targets and identified for training opportunities as appropriate.

LOP flare activity 7/1/15 – 6/30/16

There was one flaring event requiring Causal Analysis on the LOP flare during this 12 month period. The flaring event occurred on 10/6/15 when a tube failed in a heat exchanger during startup of the Hydrocracker. The causal investigation of the flaring determined that the tube failed in a circumferential direction. The heat exchanger had been inspected during the previous turnaround using both Non Destructive Examination (NDE) as well as sensitive helium leak testing. The exchanger had passed these inspections but a crack in the circumferential orientation would not have been detected by this type of testing. Reliable detection of this type of cracking requires use of custom-built inspection probes. A prevention measure to acquire and use custom-built Eddy Current Tube inspection probes was implemented as a result of this flaring event to reduce the potential for future flaring due to the same cause.

There were 11 small flaring events during the year on the LOP flare. None of the small events were planned. All but one of the 11 events lasted less than 15 minutes. Every flaring event that occurs is reviewed and shared across the refinery for awareness. The largest of the small events lasted about an hour and occurred due to a process upset in the Catalytic Cracking Unit. Operations responded quickly to stabilize the unit and minimize the amount of flaring.

LOP flare activity 7/1/14 – 6/30/15

There were no flaring events requiring Causal Analysis on the LOP flare during this 12 month period. There were 11 small flaring events during the year. None of the small events were planned. Every flaring event that occurs is reviewed and shared across the refinery for awareness.

Nine of the 11 small flaring events were very small - less than 10% of the reportable flaring event trigger. Of the 11 events, one of the two larger events occurred when a bird flew into a 12 kv power line resulting in a power outage that affected several units. MRC electricians and operations worked quickly to restore power and minimize flaring. The other larger event occurred while one of the two LOP flare recovery compressors was shut down for a planned overhaul. The remaining in-service compressor developed a valve problem that required a shutdown to repair. Before the compressor was shut down, the flare header load was minimized as much as possible and the work was staged to be done as quickly as possible. The aggressive response to this unplanned problem resulted in minimal flaring and the compressor being down less than one hour.

LOP flare activity 7/1/13 – 6/30/14

There was 1 flaring event requiring Causal Analysis on the LOP flare during this 12 month period. Prevention measures were developed and implemented as a result of this flaring event to reduce the potential for future flaring due to the same cause (see Section 3 – Reductions Previously Updated). The one flaring event on the LOP flare triggering causal analysis occurred on 5/23/14 when a low pressure vent gas compressor shut down suddenly due to high liquid level in the compressor suction liquid knockout drum. The causal investigation determined that the root cause of the flaring was abnormal operation that resulted from the sudden shutdown of the 2nd stage of the hydrocracker unit due to a faulty control valve positioner. Three prevention measures were implemented to prevent this from happening in the future.

There were approximately 8 small flaring events on the LOP flare during the year that were less than the causal analysis triggers of 500 MSCF of vent gas to the flare or 500 lb SO₂ emitted. None of these events were planned. Two of the eight were the result of preemptive natural gas injection into the flare header. The natural gas is added when the flare header pressure gets close to the pressure where the water seal breaks. This preemptive injection is to ensure good combustion in the flare by adding natural gas. Most of the other small events were generally caused by pressure spikes in the flare header (e.g. when a pressure safety valve relieved below its set point) overwhelming the recovery compressors. This is excellent performance especially since several units on the LOP flare system went through turnaround during this period.

LOP flare activity 7/1/12 – 6/30/13

There were 4 flaring events requiring Causal Analysis on the LOP flare during this 12 month. Prevention measures were developed and implemented for each of these events to reduce the potential for future flaring due to the same cause (see Section 3 – Reductions Previously Updated).

Two of the events were related to the same issue. Flaring occurred on 9/8/2012 and again on 1/19/2013 when the LOP flare gas recovery compressors were bypassed in order to isolate the flare knock-out and water seal vessels. The flare vessels had to be isolated to take them out of service for required API-510 ten-year pressure vessel inspection. Because the LOP flare system was originally built without isolation valves, the only way to isolate the vessels was to install blinds. To install the blinds, the flare gas recovery compressors had to be bypassed resulting in flaring. Prior to the planned flaring, MRC evaluated prevention measures to eliminate the flaring. It was confirmed that there was no way with the existing equipment configuration to isolate the vessels without flaring. To prevent having to flare for future inspections, refinery management approved a \$4MM project to install isolation valves and piping as part of the vessel inspection work to allow vessel isolation in the future without flaring. Careful planning prior to the inspections identified a way to conduct the inspections with two rather than three flaring events which minimized the amount of flaring that had to take place.

The third flaring event on the LOP flare triggering causal analysis occurred on 8/13/12 when a lube oil fire shut down a high pressure hydrogen compressor tripping the 1st stage of the hydrocracker. The shutdown resulted in flaring on both the LOP and FXG flares. The causal investigation determined that the lube oil escaped from the compressor bearing seals after the gravity drain from the compressor to the oil reservoir became restricted due to overflow of the reservoir. The lube oil reservoir was overfilled when the manual fill valve was left open. Prevention measures have been implemented to prevent this from happening in the future.

The fourth flaring event occurred on April 5, 2013 due to excess pressure in the refinery's 200 lb hydrogen system resulting in hydrogen relieving into the LOP flare header, breaking the water seal

and causing flaring. The overpressure occurred while the refinery was attempting to maximize flexigas consumption in the hydrogen plants to prevent flexigas flaring when several units were down for maintenance.

There were approximately 12 flaring events on the LOP flare during the year that were less than the causal analysis triggers of 500 MSCF of vent gas to the flare or 500 lb SO₂ emitted. None of these events were planned and all but one lasted less than 15 minutes. Five of the 12 were due to instrumentation issues including a broken air line on a control valve, a faulty level transmitter and a bad circuit board. Six of the 12 were related to shut down or start up activities when unplanned flaring is more likely due to non-routine operation. One of the events was due to a compressor surge condition causing a process upset. All of the flaring events were quickly investigated when they occurred to determine the cause, stop the flaring and implement any identified prevention measures. For example, rods were installed to minimize the vibration that had caused the copper tubing air line on the control valve to break.

LOP flare activity 7/1/11 – 6/30/12

There were no flaring events requiring causal analysis on the LOP flare during this 12-month period. This period included a major turnaround on the Fluid Catalytic Cracking Unit which was successfully accomplished without any flaring. There were 8 small flaring events during the year that were reported on the monthly flare reports. None of these flaring events were planned. Six of these events were less than 5% of the 500 MSCF causal analysis trigger and were the result of small upsets during maintenance activities or as a result of mechanical failure.

The largest flaring event on the LOP flare during this time period occurred when a motor control center breaker tripped resulting in the sudden shutdown of approximately 50 motors in a gas processing unit. The sudden shutdown of the equipment resulted in flaring. The flaring was stopped in less than an hour and did not exceed the Causal Analysis triggers. An investigation was conducted and determined that the problem was caused when a single pump motor failed to ground due to excess vibration and its breaker did not immediately trip to clear the fault. The next upstream protective device, a main breaker, tripped causing the sudden shutdown of multiple pieces of equipment. A plan is being implemented to identify breakers similar to the one that failed to trip and to consider replacing them.

LOP flare activity 7/1/10 – 6/30/11

There were two flaring events requiring causal analysis on the LOP flare during this 12-month period.

The first event occurred on 8/21/10 when a low pressure vent header compressor tripped offline due to a broken governor. The investigation into the event determined that the likely cause of the governor failure was a surge condition on the compressor. One of the prevention measures implemented to reduce the likelihood of flaring due to this cause was installation of an anti-surge controller. The amount of flaring that resulted from this event was minimized by slowing down several major process units so that the low pressure vent header could be re-routed to stop the flaring.

The second flaring event triggering causal analysis occurred on 10/4/10 when a leak developed on the common discharge line from the flare recovery compressors. The only way to safely repair the leak required the shutdown of the flare recovery compressors. Prior to shutting down the compressors, the volume of flare gas was minimized as much as possible by re-routing low pressure vent streams that are normally recovered by the compressors. The primary cause of the leak was

determined to be external corrosion of the piping that occurred underneath the externally jacketed insulation as a result of water penetration.

There were 15 small flaring events that occurred during this time period and were reported on the monthly flare reports. None of these flaring events were planned and most were due to mechanical failure or process upset. All but three of these events were less than 10% of the 0.5 MMSCF causal analysis trigger and lasted only a short time. Information was collected after each event to try to identify the cause and any prevention measures that could be implemented. For example, several small flaring events occurred due to plugging that was occurring in the discharge line of one of the flare vapor recovery compressors. This plugging was reducing the amount of capacity that the compressor could recover. The cause of the plugging was determined to be salt buildup in the line and was traced back to a sour water stripper vent that was lined up to the flare. The vent was re-routed out of the flare header and the plugging problem was eliminated.

LOP flare activity 7/1/09 – 6/30/10

There were no reportable flaring events greater than the 0.5 MMSCF trigger for causal analysis on the LOP flare during this 12- month period.. There were 13 small flaring events reported on the monthly flare reports. None of these flaring events were planned. All but two of these short events were less than 10% of the causal analysis trigger. The other two small flaring events were less than 25% of the trigger. Available information was captured on each of these events to help understand why the flaring occurred and what could be done to prevent it from occurring again. For example, the largest of the small flaring events occurred when a contractor erecting scaffolding accidentally broke the air supply line to a control valve on a vessel causing the valve to fail in the open position to the flare (the safest position). Operations quickly identified the cause of the flaring and was able stop the flaring in less than 20 minutes. A discussion was held with the scaffolding contractor to reinforce the need for care when working on and around equipment.

LOP flare activity 6/1/08 – 6/30/09

There were no reportable flaring events requiring causal analysis on the LOP flare during this 13-month period. Five minor events were reported on the monthly flare reports. This time period included turnarounds on several major units served by the LOP flare system. With careful planning, per procedure C(F)-21, the environmental impacts were assessed, communicated, and managed resulting in no reportable flaring events. None of the flaring was planned. Most of the events were < 10 minutes long. The majority of the events occurred as a result of process upset or mechanical failure.

LOP flare activity: 1/1/06 – 6/1/08

There were two flaring events requiring causal analysis (events greater than 0.5 MMSCF or 500 lbs of SO₂) on the LOP flare between 1/1/06 and 6/1/08 and approximately 36 minor events that were reported on the monthly flare reports.

The two reportable flaring events both occurred in January 2007 and were unplanned events due to process upset or malfunction of equipment. An event in March 2006 did not trigger a causal analysis on its own but the emissions were included when the flexigas flaring due to the event tripped the 0.5 MMSCF trigger. These flaring events were investigated and prevention measures identified and implemented (see Part 3 of this Section – Reductions Previously Realized). The results of the investigations into these events were reported to the District in Causal Analysis reports. None of the flaring that occurred, including the minor events, was planned. All flaring, when it occurred, was minimized and stopped as quickly as possible.

Beginning in November 2006 with the adoption of the Flare Procedures described in the Common Measures Section, pertinent information, when available, was captured immediately after a flaring event to determine the cause of any flaring and what could be done to prevent it from happening again. Total emissions from all flaring during the period from 12/1/06 through 6/1/08 were: 0.6 tons of methane, 0.99 tons of non-methane hydrocarbon and 2.5 tons of SO₂. Figure 2a presents a comparison of the average emissions per large reportable events over this time period vs. the average emissions per small event. This figure shows that small events contributed on average < 10% of the emissions of a large event. Figure 2a reinforces the appropriateness of the causal analysis trigger of 0.5 MMSCF/ 500 lbs SO₂ to ensure the resources to conduct a Causal Analysis are most effectively applied to address high emission events.

FIGURE 2008 –1

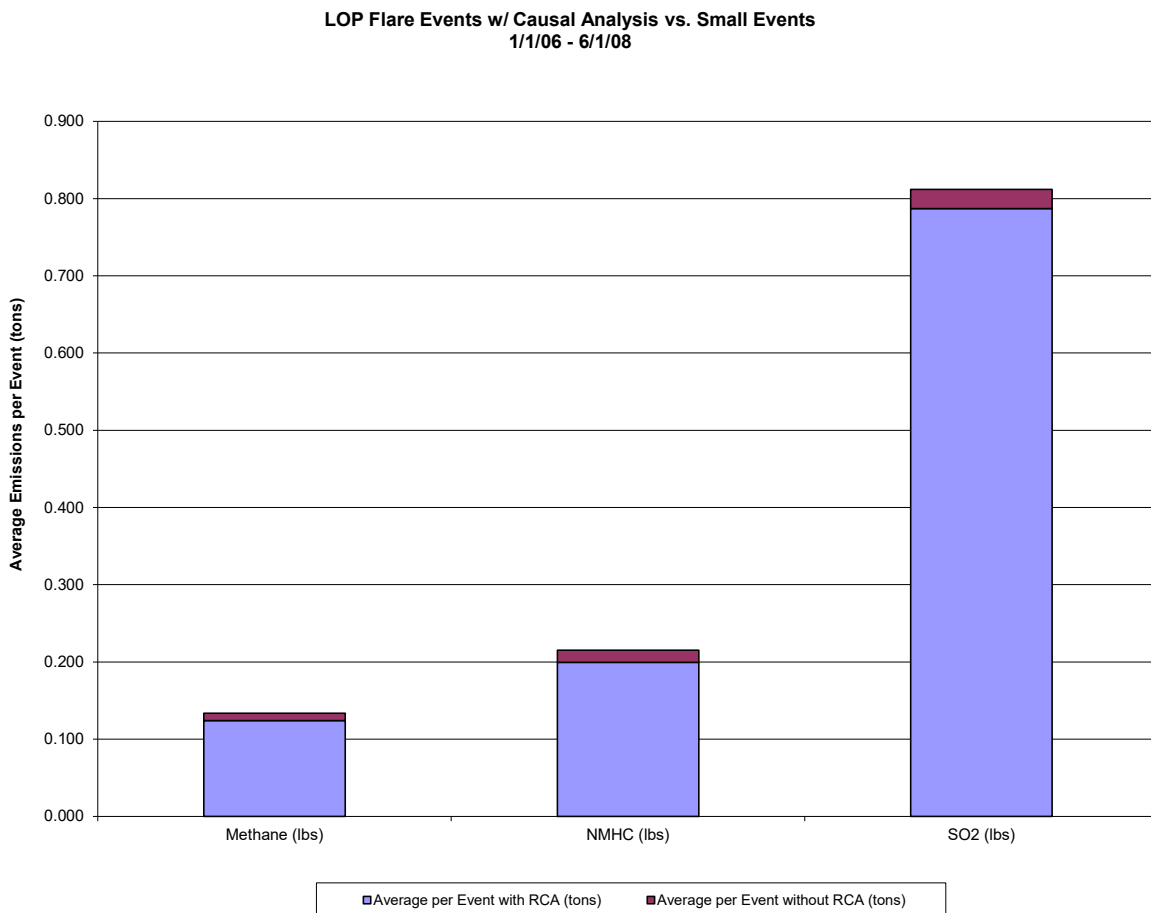

LOP Flare Activity 2004 – 2005

There was one reportable flare event³ on the LOP flare during 2004 and 2005. That single emergency flare event was an unplanned electrical power outage in December 2005 that resulted in almost half of the non-methane hydrocarbon emissions during the entire two-year period (0.5

³ Reportable Flare Event as defined in Regulation 12-12 Section 208 is any flaring where more than 500,000 standard cubic feet is flared or sulfur dioxide (SO₂) emissions greater 500 lbs per day.

tons). Total emissions for both years combined (including the emergency flaring) were 1.06 tons of non-methane hydrocarbon in 2004-2005. Even including the emergency flaring, recovery of gas from the collection header exceeded 99.7%. Emissions of non-methane hydrocarbon were less than 3 pounds per day, which is less than 0.2% of the refinery's permitted emissions.

Minor flare activity occurred on 40 occasions during 2004-2005. Most events lasted for less than 20 minutes, and typically less than 10 minutes. The distribution of these events offers no single focal area providing significant leverage for feasible prevention measures. The variety of causes, and the distribution of events among these causes, means preventative measures must consider a wide scope; including mechanical reliability, improved handling of startup and shutdowns without flaring, and reducing the impact of process upsets.

Historical Flaring Review Discussion: Historical flaring at the LOP flare was reviewed to identify opportunities for feasible prevention measures. The review addressed the five year period from 2000 to 2005 and included both emergency and non-emergency flaring. Prior to January 2004 when ultrasonic flow meters became operational, flare flows were not accurately measured, making any thorough analysis impractical. For these earlier periods the review relied upon internal Environmental Incident reports, Operations' shift logs, reports and communications to the District and other regulatory agencies.

Flaring prior to January 2004

Review of flare events prior to January 2004 provided little usable information. Without flow meters, neither durations nor volumes could be accurately determined. In many cases, even the proximate cause of flaring could not be reliably determined due to the limited documentation and time elapsed since the event. With these qualifications, a breakdown of the general cause of LOP flare events for the previous five years is depicted in Figure 2. A description of the various categories listed is provided below:

Upset: Flaring attributed to process upsets.

Mechanical Failure: Flaring attributed to mechanical or instrument failure.

Power Outage: Flaring related to electrical outage (similar to process upset).

SU/SD: Flaring attributed to process start-up and shutdowns. Planned flaring due to startup and shutdown has generally been eliminated in recent years by procedural revisions. In some cases this includes use of temporary facilities for selected activities.

Fuel Imbalance: Flaring resulting from temporary imbalance in the fuel system. These events are typically very brief and are generally caused by a process upset at another unit that is a consumer of refinery fuel gas.

Based on these data, about 65% of the flare events occurring from 2000 - 2005 are essentially evenly divided among the following categories: process upsets, process startup and shutdowns, mechanical failures of compressors and other equipment. Almost one quarter of the time the occurrences where the water seal was broken indicating that flaring occurred were so small, and of such brief duration, no cause could be reliably determined.

**Figure 2. LOP Area Flare Events
(2000-2005)**

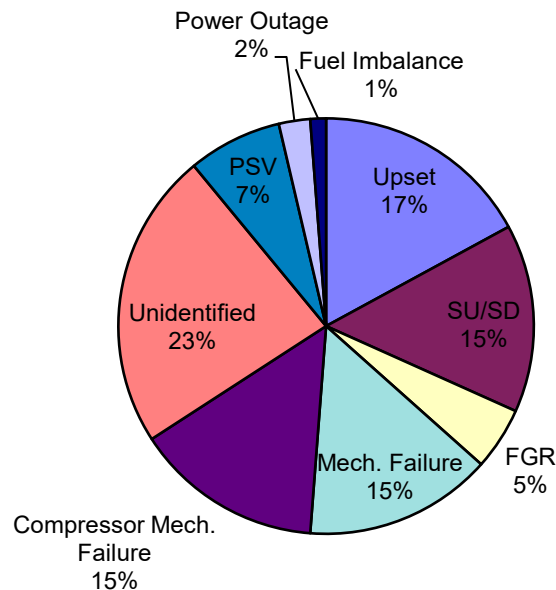

There has been a significant decrease in the number of flare events caused by fuel system imbalance and startup/shutdown in recent years. This is a direct reflection of the increased emphasis on reducing flaring. Regardless of historical performance, major turnarounds in the recent past on units served by this flare have been performed without planned flaring. That this work was performed without planned flaring is evidence of careful review and planning. MRC is committed to continue this careful review and planning prior to planned major maintenance and expect to perform turnarounds with little or no planned flaring. Therefore there is no predicted flaring resulting from planned major maintenance for which to evaluate prevention measures against. If during the maintenance planning and review process MRC finds that planned flaring is required, all appropriate prevention measures will be considered and feasible measures will be implemented to reduce or eliminate the planned flaring.

Further reductions have been achieved through improvements in mechanical equipment reliability associated with changes in maintenance evaluation and practice.

Flaring during 2004 and 2005

The highest quality data are available for the period from January 2004 to January 2006. This generally coincides with installation of the ultrasonic flare flow meter and BAAQMD flare reporting required per Regulation 12 Rule 11. Available data for flare event volume, rates and durations are provided in Figures 3 through 5 below. This information will be used to evaluate environmental impacts and potential options to further reduce flaring.

Volumes flared: Figure 3 depicts the amount of material flared during the 25 events occurring in 2005. Each point on this plot represents the total flare volume of gas during that event. The vertical axis is relative magnitude of that event compared with all events in the period. Based on this figure, ninety percent of the events had volumes less than 100 thousand standard cubic feet (MSCF) per event. Approximately five percent had volumes between 100 and 200 MSCF per event. A single emergency event resulted in flaring more than 500 MSCF.

Therefore, if sufficient recovery compressor capacity could be installed to meet the flare flow rate that occurs during the flaring events, providing storage for the equivalent of 200 MSCF of flare gas volume would be adequate to contain about 90% of the number of events⁴. To determine the recovery compressor capacity that would be needed requires information concerning the flaring event flow rates and duration. This is described below.

Flare flow rates: The amount of flare gas that can be recovered depends upon compressor capacity and gas properties. Compressor capacity is typically described in terms of gas at standard conditions, however compressors are forced to work with gas at actual conditions. At the elevated temperatures which often occur in flare events, this difference between actual gas volume and the gas volume at standard conditions may be significant. For example, a compressor with a capacity of 3.2 million standard cubic feet per day (MMSCFD) has a capacity of approximately 2.2 MMSCFD for gas at 300 F.

Figure 4 depicts the average rates of flow to the flare for events occurring in 2005. These data indicate that approximately 30% of the flare events had event-average flow rates of less than 3 million standard cubic feet per day. Actual instantaneous rates are generally higher – often significantly – than these average rates. This difference between the average rate for an event and instantaneous flare gas rate during an event is important because once the instantaneous rate exceeds the available compressor capacity the water seal is typically broken and flaring occurs. Once flaring begins, backpressure in the flare header provided by the water seal is significantly reduced. Due to the lower header pressure, flare gas recovery rates are typically significantly reduced from their rated capacity.

Data from Figure 4 were used to evaluate the leverage provided by additional flare gas recovery in LOP. As each increment of compressor capacity was added, the corresponding events with average flows within the newly revised total capacity were considered to be recovered rather than flared. Similarly, the reported emissions for these events were presumed not to occur. This provided the basis for emissions reductions as a function of compressor capacity.

Flare event durations: The duration of a flare event affects both our ability to determine the cause of the flaring and the alternatives for flare gas recovery. Events that have a very short duration require the flare gas recovery equipment to operate continuously. Events lasting for several hours may allow some equipment to be shutdown under normal conditions and then started when an event occurs.

Figure 5 depicts the distribution of flare event durations for 2005, the year for which these data are available. Most flare events have very short durations with small volumes of gas flared. From Figure 5 it can be seen that half of the flare events had durations of less than 10 minutes. By combining event durations with additional data on the volume flared during each event, it can be shown that the 50% of events with durations less than 10 minutes contributed less than 10% to the

⁴ The elevated temperature of compressor discharge flows requires storage volumes greater than those required for gas at standard conditions. For a 300 Degree F gas, the required actual volume is approximately 50% greater than that calculated for standard conditions.

total volume of gas flared. The 85% of events which lasted 15 minutes or less contributed less than 40% to the total volume flared. Only three of the flare events during this period lasted longer than one hour. All of the event durations were less than three hours.

This distribution of event durations affects how flare gas recovery compressors must be operated. One possibility to reduce flaring would be to make use of standby flare gas compressor capacity for higher than normal flare gas loads. During an unplanned event that produces significantly more flare gas than for average operating conditions, refinery operations would need at least 15 minutes from the time when higher than normal flow began before an additional recovery compressor could be brought online to handle the increased demand. The brief durations of the bulk of these flare events means that any additional recovery compressors would have to be operating continuously if they were to recover the gas from these events. A standby compressor that was only started after flare gas flowrates increased would miss much of the flare gas flow before it could be brought online. In addition this practice has been shown to create a distraction on operating personnel at the very time their assistance is more appropriately directed to controlling the conditions responsible for the process upset.

Electrical costs associated with running an additional compressor at the time of the event must be included in the economic evaluation. This increases the cost and therefore decreases the cost-effectiveness of emissions reductions.

An additional consideration is that the brief duration of many flare events makes it more difficult to determine their cause. Often excess flow to the flare gas header has stopped before significant troubleshooting activity can be undertaken to determine its source.

**Figure 4. LOP Flare Gas Flow Rates
(2005)**

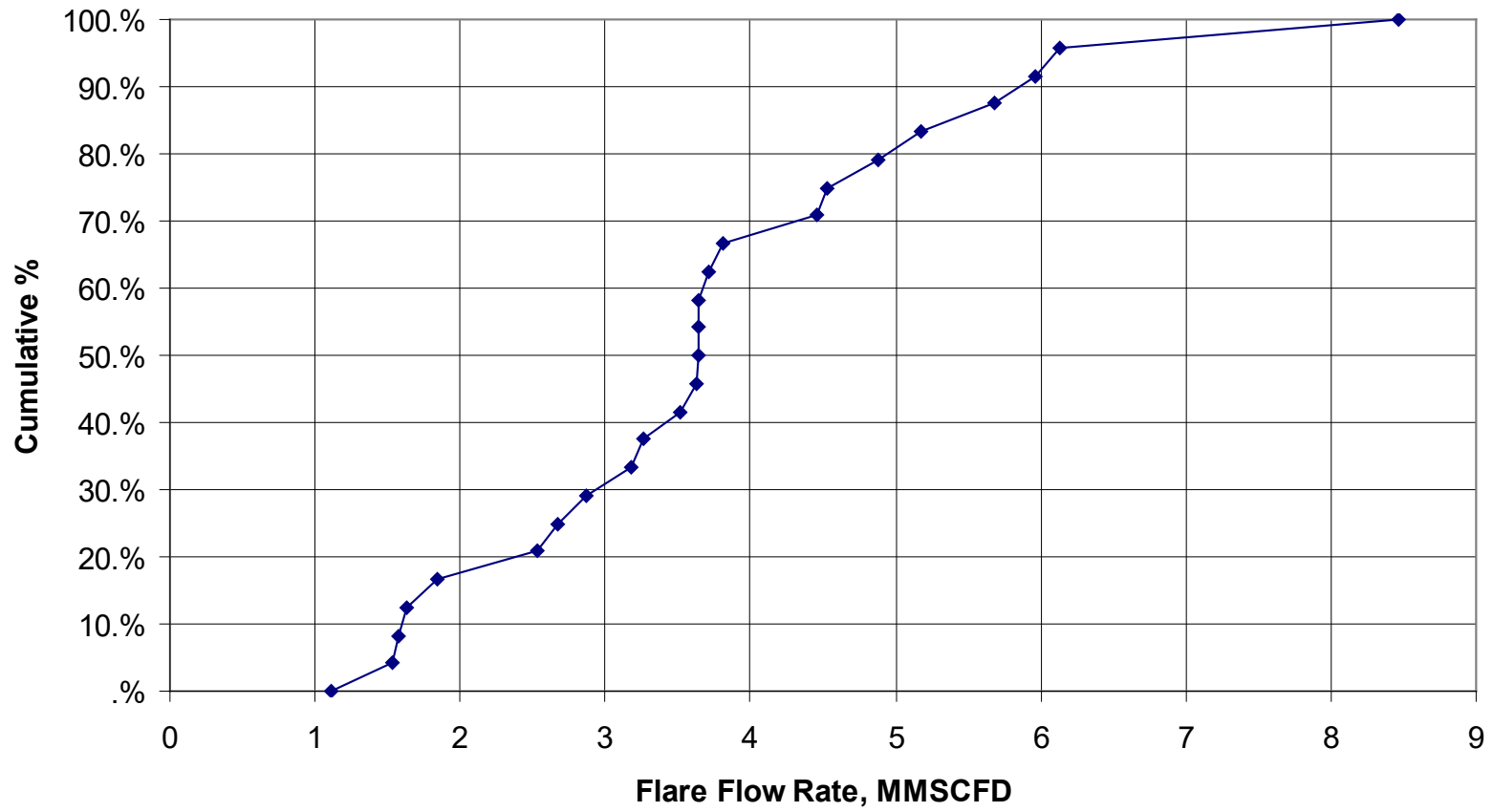
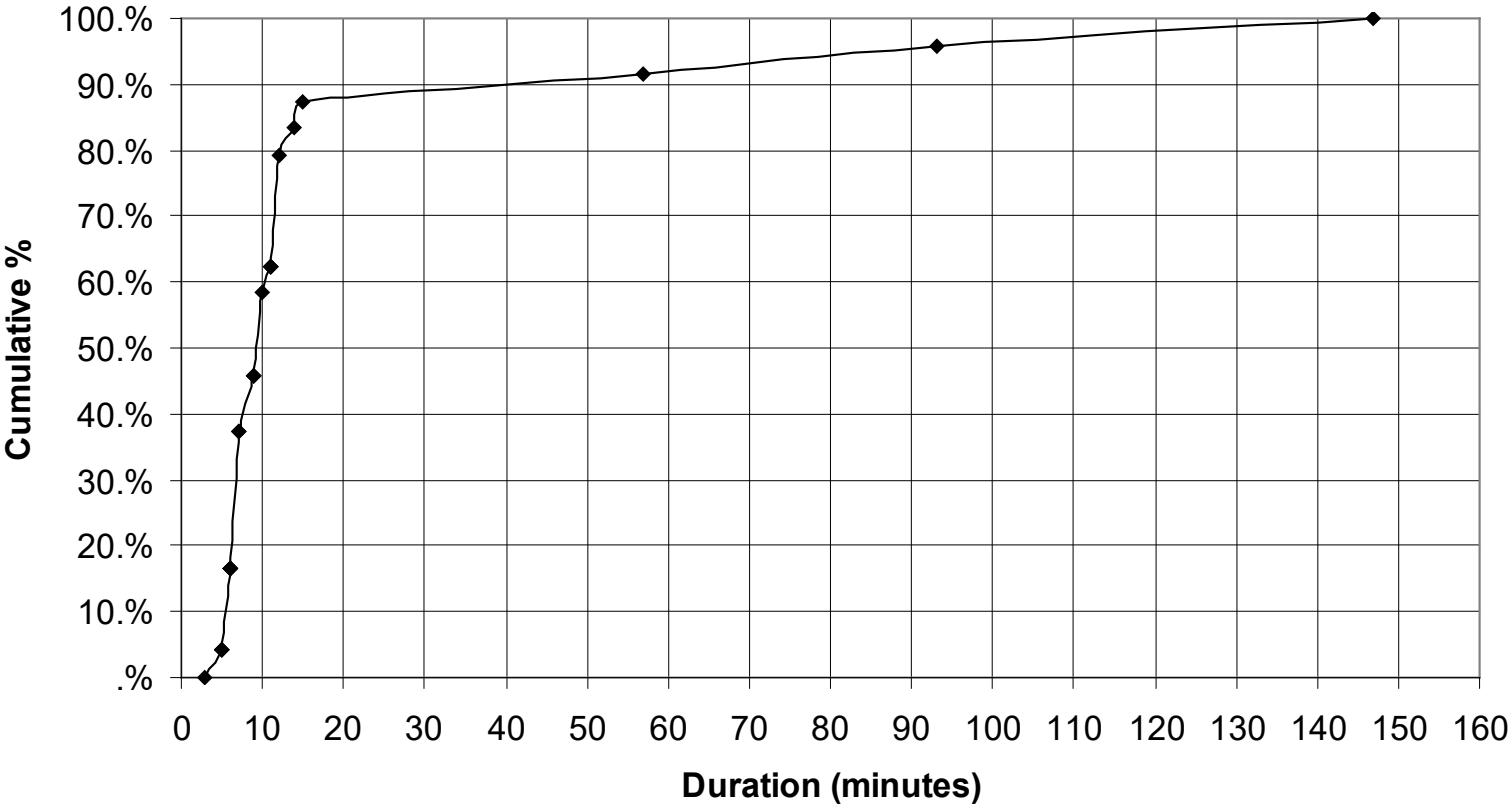

Figure 5. LOP Flare Durations
(2005 - 25 Events)



III. REDUCTIONS PREVIOUSLY REALIZED (12-12-401.2)

Equipment, processes and procedures installed or implemented to reduce flaring at the LOP flare are described below.

HARDWARE AND PROCESS REVISIONS

A variety of hardware modifications and operational and procedural changes have been made in LOP that help to reduce flaring in some circumstances. These include:

- (A) Following the December 2005 flaring event that was the result of a power outage due to a ground fault, electrical sub stations at the refinery were upgraded to further limit potential for water intrusion that may cause ground fault.
- (B) Available flare gas recovery capacity in LOP was increased 0.3 MMSCFD by rerouting the Crude Unit vacuum flasher overhead vent to the Delayed Coker main fractionator. When the Delayed Coker is shutdown, or this routing is unavailable for any reason, the vent flow is returned to its historical disposition. This additional flare gas compressor capacity was made available in 2005.
- (C) The pressure control target for the Fuel Gas Blend Drum was adjusted in 2002 to assure a cushion of natural gas, when this stream is being used to pressure control the blend drum. This provides a greater dampening for operational swings in fuel gas supply or demand that may otherwise result in flaring. Several revisions were made to the fuel gas blend drum pressure control as part of the project. The previous control scheme relied on natural gas to pressure control the refinery fuel gas system. The capability to control pressure with other streams was extended to include a second natural gas control valve (to increase the control range) and vaporized propane or butane streams. This flexibility allows us to pressure control the blend drum over a wider range of operating conditions. In addition, operating guidelines were changed to assure that the fuel balance provided enough flexibility to absorb the return flows from tank vapor recovery as they cycle on and off during the day. Since these flows are driven by atmospheric conditions they cannot be accurately predicted or controlled.

These changes reduce flaring because the fuel component that is controlling blend drum pressure is present in a high enough volume so that the fluctuations in operating conditions can usually be accommodated without overpressuring the system.

- (D) Over the past few years, the refinery has implemented a variety of operational strategies to consume fuel and minimize flaring during periods where fuel availability temporarily exceeds demand. These strategies are described in procedure C(F)22.
- (E) Flaring occurred on the LOP flare in December 2005 when a low-pressure vent gas compressor experienced a surging event due to the process conditions that resulted from a power outage. The flaring lasted longer than it might otherwise have lasted due to a problem with a control valve requiring manual operation from the field. The causal analysis that was conducted for the flaring event identified making repairs to the control valve to allow the automatic addition of propane to the suction of the compressor as a prevention measure that could be implemented during the next turnaround. On January 12, 2007, another flaring event occurred on the LOP flare and the same prevention measure was identified. Repairs to the control valve were made in February 2007 to allow propane to be automatically added by the Board Operator to the suction of the compressor. Another prevention measure that

was identified in the 1/12/07 flaring event report included repair of a variable pitch control on three fixed pitch fans. This item was completed in July 2007.

- (F) A flaring event occurred on March 19, 2006 that resulted in flaring on both the LOP and FXG flares. The flaring occurred when the Catalytic Reformer Unit shut down during a reactor switch. The prevention measures identified in the Causal Analysis report have all been implemented. The prevention measures included development of a rigorous interlock bypass procedure and QA/QC plan for MOV interlocks. Operator takeover training manuals were revised to include more detail concerning shutting down compressors and expectations regarding operations shift turnover reports were reinforced. Hydrogen system automation and addition of a high-pressure alarm were considered and determined not to be needed due to installation of a new check valve instead.
- (G) A flaring event occurred on 1/16/07 on the LOP flare when the oxygen analyzer on the flare recovery system failed. The recovery system automatically shutdown for safety reasons when the analyzer failed. To prevent this flaring event from occurring again, the oxygen analyzer sample line heat-tracing system and sample block heater were re-energized and procedural revisions made as described in (D) in the next section.
- (H) A flaring event occurred on 8/21/10 on the LOP flare when low pressure vent header compressor shut down due to a broken governor. The governor failed due to a surge condition on the compressor. To help reduce the likelihood of surging on this compressor, an automatic anti-surge controller was installed.
- (I) Flaring occurred on both the LOP and FXG flares on 8/13/2012 when the 1st stage of the hydrocracker shut down due to a lube oil fire on a hydrogen compressor. The primary cause of the flaring was overfill of the lube oil reservoir when the manual reservoir filling valve spring closure mechanism was defeated and the valve was left open during filling. The reservoir design was reviewed to determine if there were any design alternatives to reduce the risk of overfill. As a result of the review, a shut off valve was installed that stops the lube oil flow to the reservoir after 10 gallons. The review and subsequent valve installation were complete by June 30, 2013.
- (J) Planned flaring occurred on the LOP flare on both 9/8/12 and 1/9/13 in order to install blinds to isolate flare liquid knockout and water seal vessels for required ten-year API pressure vessel inspection. During the outage for the inspection, isolation valves and piping were installed to allow isolation of the vessels in the future without flaring.
- (K) A flaring event occurred on 6/15/17 on the LOP flare when a failure occurred on the I/P transducer on a pressure control valve on the fuel gas blend drum that allowed treated fuel gas to leak into the flare header. The transducer was replaced with a newer model in June 2017.
- (L) The pump that caused the June 7, 2019 was overhauled and modified to a design that will minimize the opportunity for debris to collect in the seal chamber, reducing the likelihood of debris impacting the seal integrity.

- (M) As a result of the January 16, 2020 flaring event, a level transmitter used for a column in the SGP was replaced with a design that decreases the likelihood of water entering the transmitter.

PROCEDURAL REVISIONS

The LOP Area Flare header is provided with vapor recovery. Operating personnel in process units served by this flare have extensive experience managing background flare header flow within the capacity limits of the compressors. These activities include: managing startups, shutdowns, vessel depressuring and maintenance. Careful management of these activities is an expectation to minimize or prevent flaring.

- (A) Historical flaring in LOP shows strong dependence of flaring upon the reliability of rotating equipment, including flare gas recovery compressors. Compressors are required to increase the pressure of gases within the flare header to the pressure in the fuel system. If compressors are unavailable for any reason, gas in the flare header cannot be recovered. To maximize available compressor capacity, maintenance practices and schedules are regularly reviewed.
- (B) The Environmental Impacts assessment practice for turnaround and maintenance work has been in place for several years. According to this practice, prior to each turnaround and major maintenance block, including the related shutdown and startups, the operating department and turnaround groups discuss ways to minimize flaring. This practice is formalized in procedure C(F)21 described previously in this FMP.
- (C) A 1/12/07 flaring event on the LOP flare occurred when a vent gas compressor lost suction due to surging and a PRV relieved to the flare during shut down of a process unit. Changes to the unit shutdown procedures were made to note the importance of monitoring the compressor during shutdown for potential surging due to changes in feed gravity, to include a step for propane addition to the vent compressor suction to increase gravity during abnormal shutdown conditions, and to caution about blowing through the high pressure separator and overpressuring the low pressure separator during shutdown.
- (D) The scope and frequency of the preventative maintenance plan for the oxygen analyzer on the LOP flare gas recovery system was reviewed after a flaring event occurred on 1/16/07. The review included the heat tracing system, sample block heater and liquid removal system. The procedure was revised in June 2007 to add a weekly check of the liquid disposal system.
- (E) After a surge condition resulted in a broken governor which shutdown the low pressure vent header compressor on 8/21/10, the training procedure was updated with learnings from this event to better manage and respond to future surge conditions. The training was completed by 4/25/11.
- (F) Flaring occurred on both the LOP and FXG flares on 8/13/12 when a high pressure hydrogen compressor and the 1st stage of the hydrocracker unit shut down due to a lube oil fire. The primary cause of the flaring was overfill of the lube oil reservoir when the manual reservoir filling valve was left open. The spring return-to-close mechanism on the valve had been defeated. To attempt to prevent this from happening in the future, the following prevention measures were implemented:

- a. Additional training was provided to operations to describe the event and explain how overfilling a lube oil reservoir can lead to a fire. This action item was completed by 12/31/12.
 - b. The ergonomics of the lube oil reservoir filling operation was reviewed to determine if there were any opportunities to reduce discomfort during longer filling operations which may have been why the closure mechanism was defeated. The review was completed by June 30, 2013 and the ergonomics found to be acceptable.
- (G) Flaring occurred on the LOP flare on 4/5/13 due to overpressure in the 200 lb hydrogen header. The increase in pressure occurred while trying to maximize flexigas combustion in Hydrogen Plant 2 (HP-2) to prevent flexigas flaring while several units were down for a maintenance outage including Hydrogen Plant 1 (HP-1) that normally maintains operational control for the refinery hydrogen system. Clear understanding of the operational control for the hydrogen system during abnormal operation (with one hydrogen plant down) contributed to the event. To help prevent this from reoccurring, two prevention measures were implemented:
- a. The alarm set point on the HP-2 hydrogen vent was reduced to 70% with specific instructions to eliminate the back pressure on HP-2. This change was complete by June 15, 2013.
 - b. Refresher training was conducted on operational control of the hydrogen system when HP-1 is down to ensure clear understanding of who has control during this situation. The training was conducted by June 15, 2013.
- (H) Flaring occurred on the LOP flare on 5/23/14 when a low pressure vent gas compressor shut down on high liquid level in the compressor suction liquid knockout pot. The root cause of the event was a faulty control valve positioner. As a result of this event, a new procedure was developed for hot-starting the compressor after a trip to minimize the amount of time the compressor is off-line after a trip and the amount of flaring that would occur during a similar event. In addition, the control valve positioners in similar service in the affected unit were inspected to ensure tight linkage to help prevent a flaring event from the same cause. These prevention measures were complete by July 1, 2014.
- (I) Flaring occurred on the LOP flare on 10/6/15 when a tube failed in a heat exchanger during startup of the Hydrocracker. The causal investigation found that the tube failed in a circumferential direction. The heat exchanger had been inspected during turnaround using both Non Destructive Examination (NDE) as well as sensitive helium leak testing. The exchanger had passed all inspections but a crack in the circumferential orientation would not have been detected by this type of testing. Reliable detection of this type of cracking requires use of custom-built inspection probes. A prevention measure to acquire and use custom built eddy current tube inspection probes was implemented as a result of this flaring event.
- (J) Flaring occurred on the LOP flare on 12/19/16 due to a partial refinery power outage that resulted in the shutdown of several process units. The power outage was caused by a trip of a main breaker in Substation 1 when the contacts on a relay were manually closed. The incident investigation learnings were shared with all electrical personnel by December 30, 2016. Three additional prevention measures were implemented:

1. The Job Safety Analysis (JSA) template was updated to include verbiage to evaluate the need for additional electrical staff while troubleshooting breaker controls and protective relaying in the main substations. This was completed on December 27, 2017.
 2. Labels were installed for protective relays to identify the corresponding breakers that will trip upon activation of the protective relay. This was completed on February 27, 2018.
 3. Information labels were added for alarms associated with breaker trips on alarm Panel 6 in Substation 1 on February 27, 2018.
- (K) As a result of the flaring that occurred on the LOP flare on June 15, 2017, additional Intellatrac readings were added and LOP flare Leak Check Guidelines were reviewed to ensure that the current method of leak detection is the quickest way to determine the source of material leaking into the flare header. Both prevention measures were completed by December 2017.
- (L) As a result of the July 8, 2018 flaring event, the CCU control system was modified to prevent the system from accepting an air flow setting below the feed diversion trip point.
- (M) As a result of the October 26, 2019 event, the procedure was updated to clarify that only one of two compressors involved in the event should be lined up at any one time.
- (N) As a result of the July 8, 2020 flaring event, an air line associated with a compressor was further isolated from other equipment to minimize the transfer of vibration to the line.

IV. PLANNED REDUCTIONS (12-12-401.3)

HARDWARE AND PROCESS REVISIONS

In light of the historical flaring review, the analysis of potential mitigation measures provided in section 401.4.2 (below), and the effectiveness of the flare policy and procedures described previously, no further hardware or process revisions to reduce flaring are planned on the LOP flare at this time. The FMP will continue to be updated at least annually to include any planned revisions developed from the causal analysis of future flaring events.

PROCEDURAL REVISIONS

The four procedures described under the section Prevention Measures Common to All Flares, were implemented in 2006. As discussed in the historical flaring review, non-emergency flaring is rare for the LOP flare. These procedures help us continue to find ways to minimize and reduce flaring where possible, but it is impossible to quantify the expected reduction in flaring. Any reduction in flaring, no matter how small, eliminates the emissions that would have occurred due to the flaring, including the emissions of non-methane hydrocarbon and sulfur dioxide.

V. PREVENTION MEASURES (12-12-401.4)

Figure 2 illustrates that there are a wide range of events that can cause flaring at LOP. The annual volume of gas flared could be reduced in two basic ways. One alternative is an increase in the capacity of the flare gas recovery system. The second is improved measures to limit the rate and volume of gas discharged to the flare gas header so that it does not exceed the capacity of the existing recovery system. These two alternative approaches are discussed below.

Increasing the capacity of the flare gas recovery system would require additional equipment. Using the cost-effectiveness calculation methodology found in the BAAQMD BACT guidelines and the expected flare emission reductions, MRC can calculate the most that could be spent on this equipment and still be considered cost-effective. Based on the historical flaring review, the average annual non-methane hydrocarbon emissions from the LOP flare are approximately 0.55 tons. Using the BACT methodology and the BACT cost-effectiveness hurdle of \$20,000 per ton of non-methane hydrocarbon emissions, the maximum annual expenditure for prevention measures, even if they could completely eliminate emissions from the LOP flare, would be \$11,000. Consequently, for the LOP flare and associated process units, the maximum justifiable capital cost of project(s) that would completely eliminate this flaring is \$44,000⁵. The analysis of potential projects later in this section shows that this amount does not buy much hardware.

An alternative approach to adding equipment is careful evaluation of current practices and procedures that can lead to flaring, and development of alternatives that are less likely to overwhelm the existing flare gas recovery system. Consideration of the factors and events that can lead to higher than normal flare gas flowrates can yield reductions in flaring that are far more cost-effective than can be achieved with additional equipment for flare gas recovery. MRC believes that flare minimization efforts are best achieved on this flare by maximizing the use of procedures, training, reliability improvement, and planning.

401.4.1 Prevention Measures for Flaring Due to Planned Major Maintenance

Figure 2 shows that activities that have occurred during startups and shutdowns have contributed to less than 15% of the flare events that occurred historically at the LOP flare. Analysis of the flaring back to 2005 indicate that flaring may have been prevented by changing operating practices, improved planning, or minor hardware revisions. The trend over the past years indicates that startup, shutdowns and maintenance-related flaring can be significantly reduced and largely eliminated with careful planning. Major turnarounds on units served by the LOP flare continue to be performed without planned flaring. That this work was performed without flaring is evidence of careful review and planning. MRC is committed to continue this careful review and planning prior to planned major maintenance and expect to perform turnarounds with little or no planned flaring. If during the maintenance planning and review process MRC finds that planned flaring is required, as was the case when preparing for the LOP flare pressure vessel inspections, then all appropriate prevention measures will be considered and feasible measures will be implemented to reduce or eliminate the planned flaring.

In order to maintain equipment, it must be cleared of hydrocarbon before opening to the atmosphere for both safety and environmental reasons. Typically this is done by transferring as much of the hydrocarbon as possible to equipment that is still in service (e.g., pumping liquids to tanks) and then multiple steps of depressurization and purging of the equipment with nitrogen to the flare collection header since it is the lowest pressure system in the refinery and allows the most complete depressurization. Careful planning to limit the depressuring/purge rate and to maintain an acceptable gas temperature and composition in the flare header can reduce the potential for flaring.

Although it may not be possible in all circumstances, MRC has found that planned depressuring and purging of equipment to the LOP flare header can typically be controlled to stay within the capacity and capability of the LOP flare vapor recovery compressors for recovery of the gases to the refinery fuel gas system without flaring. Because of the robustness of the refinery fuel gas system described

⁵ The maximum capital cost was determined using the 16.3% Capital recovery factor and additional costs referenced in the BAAQMD Best Available Control Technology guidelines.

previously, the recovered purge gas from planned events can typically be absorbed in the fuel system without adverse impact on the refinery heaters and boilers.

The review required prior to turnarounds and major maintenance, including startup and shutdowns in procedure C(F)21 will continue to improve our ability to perform these planned activities without flaring. There are occasions, typically due to equipment malfunction, when a decision has to be made to shut down a process unit or major piece of equipment within a period of hours or immediately. Although the refinery will review the impacts and attempt to minimize flaring as much as possible, it can be more difficult to eliminate flaring since it may not be possible in the limited time available to take actions to ensure the fuel gas system is balanced. There may also be occasions when flaring due to planned maintenance is unavoidable because of the configuration of refinery equipment. Flaring due to these type of events will follow procedure C(F)20 and/or C(F)21 to ensure that flaring is minimized as much as possible and lessons learned are captured for the future. As long as MRC follows these procedures, any flaring that occurs, whether predicted or unexpected, will be minimized as much as possible and the flaring reviewed to determine if there are prevention measures that can be implemented to further reduce flaring. When these procedures are followed, any flaring is consistent with the FMP.

401.4.2 – Prevention Measures for flaring due to issues of gas quantity and quality including review of existing vent gas recovery capacity of the LOP Flare System

Flaring can occur as a result of an imbalance between the quantity of vent gas produced and the rate at which it can be utilized as fuel gas. When refinery equipment that is either a producer or consumer of fuel gas is shut down for any reason, then adjustments must be made in the fuel gas system to bring it back in balance. Flaring can result if the change in fuel gas balance is large and adjustments cannot be made quickly enough (typically due to the potential for upsetting other units). Imbalance in the quantity of fuel gas can occur due to maintenance, upset, malfunction, emergencies, etc.

The range of gases that can be recovered by compressors depends on the flowrate, process conditions (e.g., temperature) and composition of the gases. The limits most often approached are gas temperature and the amount of condensable liquids. High temperature may cause the compressor to shutdown if compressor inter-stage heat exchangers cannot remove enough heat to maintain cylinder temperatures below 320 Degrees F. High concentrations of propane or butane may overwhelm the machine's ability to separate liquids. Neither of these limits are often approached for the small events which occur in the LOP area flare. High temperatures and relatively large amounts of condensable liquids that may limit the ability of flare gas compressors to recover some gases typically occur during large pressure relief events. Examples include process upsets and unplanned electrical power outages that result in a loss of cooling in the process equipment. When the hot gases cannot be cooled and condensed, pressure in the process equipment increases. To prevent equipment damage and catastrophic releases, the pressure is relieved to the flare header. The resulting relief events cannot generally be recovered by the flare gas recovery compressors – because of very large flow rates, high temperatures or large concentration of condensable vapor in the gas. If electrical power to the flare gas recovery compressors is lost, flare gases cannot be recovered regardless of the temperature or composition since the compressors cannot operate without power. These events cannot reasonably be predicted, occur very infrequently, and are characteristic of emergency flaring, which is not restricted by Regulation 12 Rule 12. During these events, returning the unit to a stable condition as quickly as possible minimizes flaring. This is the primary responsibility of Operating personnel and is described in Procedure C(F)-20 – Flaring Due To Process Upsets or Mechanical Equipment Failure. When this procedure is followed, the flaring is consistent with the FMP.

The maximum capacity of a flare gas recovery system is no more than the total installed nameplate capacity of the flare gas compressors. However, flare gas compressor capacity does not fully define the total capacity of the system. In order to recover flare gas for use in the fuel gas system, four criteria must be met. First, there must be sufficient flare gas compressor capacity. Second, the compressors must act rapidly enough to prevent the water seal from being “broken”⁶. Third, there must be sufficient gas treating capacity. Finally there must either be available storage volume or a user (e.g., heater or boiler) with a need for the gas. If any of these conditions are not met, then the gas cannot be recovered into the fuel gas system.

MRC’s vent gas recovery system does not include any capacity for storage of fuel gas or vent gas. On a continuous basis MRC optimizes the refinery fuel gas system of producers and consumers to maximize the capacity available for treatment and reuse of recovered gases. This is accomplished as described previously in the FMP under the Prevention Measures common to all the refinery flares. These Prevention Measures include:

- Adjusting the sources of fuel that are made up to the fuel gas system including purchased natural gas and propane. Having a range of streams available to provide pressure control minimizes the risk of fuel system pressures rising above target, which would otherwise result in flaring.
- Adjusting the operation of units that produce fuel gas range materials to reduce fuel gas production as much as possible (consistent with safe operation) to avoid flaring.
- Adjusting the refinery profile for consumption of fuel gas by ensuring the cogeneration unit is at its maximum capacity.
- Shifting rotating equipment to turbine drivers where feasible to increase steam consumption from steam generated in the fuel gas fired boilers. Several functions provided by rotating equipment in the refinery may be powered by either electricity or steam. This ability to shift the load between the off-site electrical grid and refinery steam boilers provides additional flexibility to balance the fuel system when there is an excess of fuel. In periods where the fuel supply is limited, motor drives maximize use of electrical power. When the refinery has an excess of fuel this equipment may be powered by steam. When the cause of flaring is the result of a process unit upset or mechanical failure, changing between steam turbine and electrical motor drivers is may not be practical and must be evaluated on a case-by-case basis⁷.

Procedure C(F)22 is in place to help manage the fuel system balance during periods of flaring.

The total gas scrubbing capacity is an integral part of the refinery fuel gas management system. The capacity available for recovered vent gas scrubbing will vary depending on the balance between fuel gas production and consumption; it will vary both on a seasonal basis and during the course of the day. Sufficient capacity can be made available in the LOP treaters for the incremental flow up to the total capacity of both flare recovery compressors.

⁶ The water seal is considered to “break” when flare gas in the inlet pipe to the water seal drum first enters the water column. This is the onset of flaring.

⁷ The use of steam drivers is less energy efficient than electricity. Regular use of steam driven equipment is evaluated considering both the reliability benefits with the increased operating costs, higher water demand, and greater emissions associated with steam production. If there is a fuel gas imbalance (for whatever reason) that results in flaring of excess fuel gas and some of that excess gas can be shifted to produce more steam, MRC won’t have to flare that amount of fuel gas. This is how shifting to steam-driven equipment can reduce flaring in some circumstances.

LOP flare gas recovery system capacity:

Total LOP flare gas recovery compressor capacity = 6.4 MMSCFD

Total LOP flare gas storage capacity = 0 SCF

LOP fuel gas treating available capacity can match recovery capacity.

Average annual non-emergency flare emissions from the LOP flare during 2004 and 2005 amounted to less than 0.1% of the annual refinery permitted emissions for both non-methane hydrocarbon and sulfur dioxide. Efficiency of the existing flare gas recovery system exceeds 99.7%, including emergency flaring from 1/1/05 – 6/1/09. An evaluation of the feasibility of eliminating this flaring by increasing the recovery of flared gas by combination of additional compressors and storage vessels is provided below⁸.

Prevention Measure Options Considered for Recovery, Storage and Treatment: Costs and potential benefits of improving gas recovery and reducing flare emissions from the current 99.7% recovery efficiency are addressed by considering the addition of flare gas recovery compression and flare gas storage. Gas treating capacity is expected to be adequate for all options evaluated. A sketch of the potential options is provided in Figure 6.

Normal operation of the revised system would have to involve continuous operation of one or more of the additional compressors to capture the short duration flare events typical on the LOP flare^{9, 10}. A line from the common discharge of the flare gas recovery compressors is routed to a new gas storage vessel. The portion of the total compressor flow above that which can be treated and used in the fuel system during flare activity is routed to the storage vessel rather than being flared. Once conditions responsible for the high flare header flow have returned to normal, a valve would open directing flow from the storage vessel back to the recovery compressor inlet header. With the flare activity now over, the flow from compressor discharge would be treated and processed as fuel.

⁸ These evaluations do not consider expansion of treating capacity since non-emergency flaring at the refinery has not resulted in the need to flare untreated gas due to limits on existing treater capacity. There is no incentive to provide increased treater capacity since it is not a bottleneck resulting in flaring. Additional storage and compression would reasonably be required to take advantage of additional treater capacity. Once these are provided it is more cost-effective in our case to reduce unit rates making room in existing treaters. This may not be the case if flaring occurred more often.

⁹ The requirement for continuous compressor operation derives from actual data showing that most events in the LOP flare last less than 10 minutes. It is impractical to expect a compressor of this size to go from shutdown to full operation rapidly enough to capture such events.

¹⁰ Presumes use of single stage liquid ring compressors. Power requirements are scaled from a nominal 2 MM SCFD machine provided with a 600 HP motor.

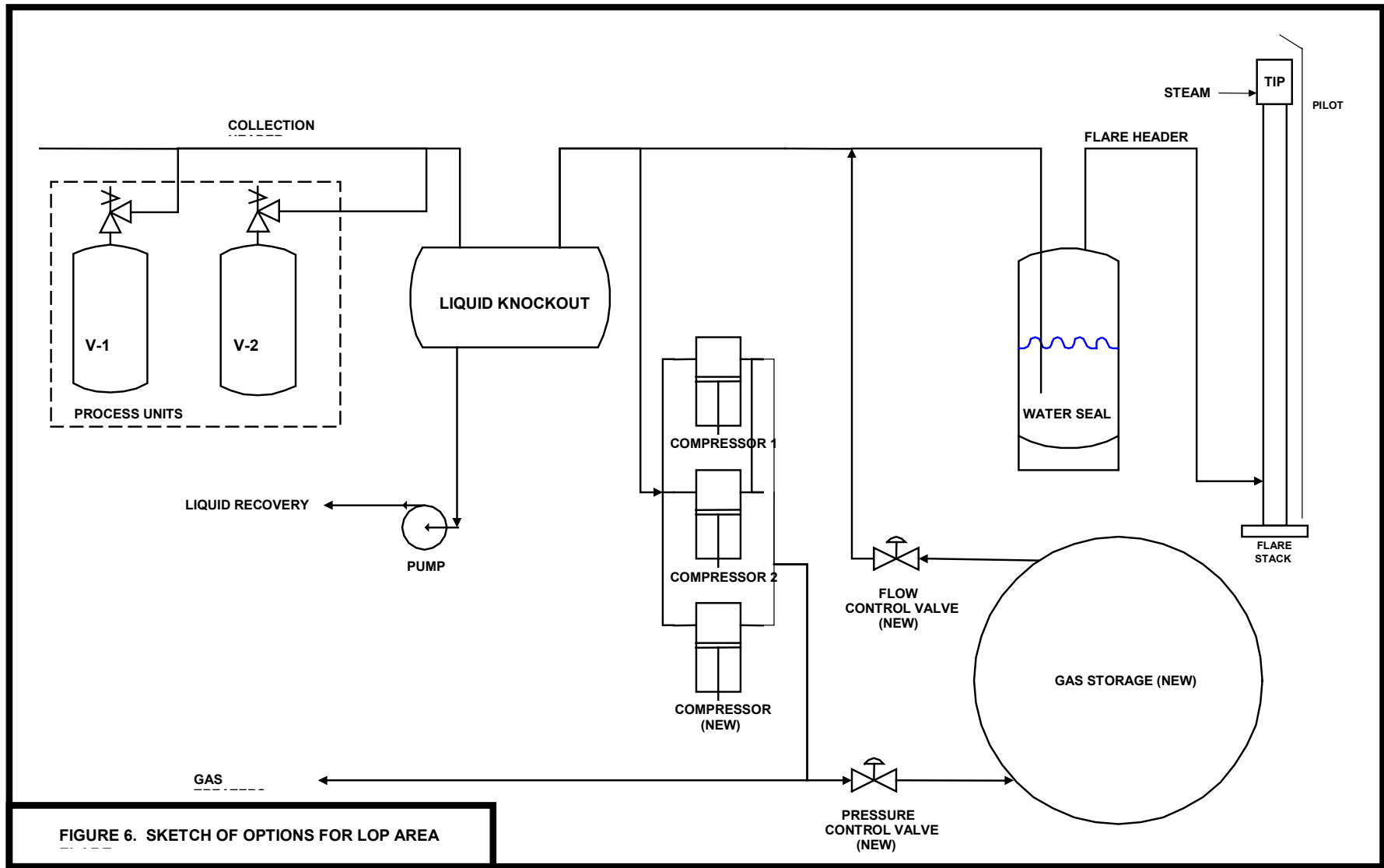

FIGURE 6. SKETCH OF OPTIONS FOR LOP AREA

Tables 1A and B depict the increased flare gas recovery and annual costs and benefits for the revised facilities considered. The evaluation makes use of data from actual flare events for calculation of potential benefits and conservatively assumes that all emissions can be eliminated, including those resulting from emergencies. Excluding the emergency emissions would result in even a higher cost per ton reduction. The evaluation below is calculated on the basis of emission reductions using the reported emissions from 2005. Even with the very conservative assumptions used in the calculations, the most cost-effective measure is still not feasible.

Table 1A considers the case of no storage, only additional compression. In this case, the emissions savings are realized only when there is sufficient purchased fuel (PG&E natural gas) in the fuel system that recovered gas can be fit in the fuel system by backing out purchased natural gas. For the purpose of this analysis, MRC has assumed that on average half of the recovered fuel would fit in the fuel system.

As depicted in Table 1A, increasing flare gas recovery efficiency from the current 99.78% by a further 0.05% would require doubling the current compressor capacity and a capital investment of approximately \$10,000,000. The cost-effectiveness for non-methane hydrocarbon emissions for Option 1A, which does not provide storage, ranges between approximately \$24 Million and \$61 Million dollars per ton. (Refer to Appendix F for additional details of these calculations).

Including emissions of greenhouse gases and non-methane hydrocarbon associated with producing the required electrical power would significantly reduce the benefit of the project. A significant reduction in benefits would occur when recovered gas does not fit in the fuel system. For these cases, there is no alternative to flaring until operating conditions of units that produce fuel gas streams can be safely adjusted to compensate for the extra fuel. This significantly decreases the benefit, increasing the effective cost to benefit ratio.

Table 1B includes additional storage in the form of a 45' diameter sphere operating at up to 120 psig. The capital cost of the sphere significantly increases total cost, but the emissions reductions are higher since the potentially recoverable gas is presumed to always fit within the capacity of the fuel system and gas treaters¹¹.

Results presented in Table 1B indicate that it may be possible to increase the efficiency of recovering potentially flared gas by almost 0.1% (from 99.78% to 99.87%), provided the system works perfectly. Electrical costs for additional compressor capacity are unchanged from the earlier example. The effect of the additional capital investment in storage is to improve the range of cost-effectiveness to between \$16 Million and \$53 Million dollars per ton. Once again, including emissions of greenhouse gases and non-methane hydrocarbon associated with producing the required electrical power will further decrease the cost-effectiveness. Additionally, permitting a flare gas storage facility in Contra Costa County is not considered in this analysis.

¹¹ Estimated cost to construct and tie into the existing system is about \$5,000,000. Storage limits the need for expanding treater capacity, and allows for capturing the fuel value and emissions savings of recovered gas. Without storage, recovered gas would most likely be burned in heaters running at lower than normal efficiency. In this event, the available non-methane hydrocarbon savings are simply the difference between the efficiency of combustion in a heater and in a flare – a number much, much, less than used for determination of estimated benefits

Table 1. Economic Justification for Additional Recovery Capacity at LOP Flare

A. No Gas Storage Provided

Additional Recovery Compressor Capacity (MMSCFD) ¹	Overall Recovery Efficiency (%)	Capital Cost (\$)	Combined Annual Cost ^{2,3} (\$/yr)	Emissions Reductions by Species (lbs/year)					Cost Effectiveness of Reductions (\$ Million/ton)				
				NMHC	SOx	NOx ⁶	CO ⁶	PM ⁶	NMHC ⁴	SOx ⁵	NOx	CO	PM
0	99.78%	-	-	-	-	-	-	-	-	-	-	-	-
3	99.79%	\$5,000,000	\$1,745,000	57	158	28	150	4	\$61	\$22	\$126	\$23	\$858
4	99.81%	\$6,700,000	\$2,335,300	203	561	98	535	14	\$23	\$8.3	\$47	\$8.7	\$323
5	99.82%	\$8,300,000	\$2,899,700	235	652	114	621	17	\$25	\$8.9	\$51	\$9.3	\$345
6	99.83%	\$10,000,000	\$3,490,000	294	816	143	778	21	\$24	\$8.6	\$49	\$9.0	\$332

B. 400,000 SCF Gas Storage Provided

Additional Recovery Compressor Capacity (MMSCFD) ¹	Overall Recovery Efficiency (%)	Capital Cost (\$)	Combined Annual Cost ^{2,3} (\$/yr)	Emissions Reductions by Species (lbs/year)					Cost Effectiveness of Reductions (\$ Million/ton)				
				NMHC	SOx	NOx ⁶	CO ⁶	PM ⁶	NMHC ⁴	SOx ⁵	NOx	CO	PM
0	99.78%	-	-	-	-	-	-	-	-	-	-	-	-
3	99.80%	\$10,000,000	\$3,040,000	114	315	55	301	8	\$53	\$19	\$110	\$20	\$748
4	99.84%	\$11,700,000	\$3,630,300	405	1,122	197	1,070	29	\$18	\$6.5	\$37	\$6.8	\$251
5	99.85%	\$13,300,000	\$4,194,700	470	1,303	228	1,243	34	\$18	\$6.4	\$37	\$6.8	\$250
6	99.87%	\$15,000,000	\$4,785,000	589	1,632	286	1,557	42	\$16	\$5.9	\$33	\$6.1	\$227

1) Capacity units are millions of standard cubic feet per day.

2) Indirect costs include Capital Recovery (10% interest over 10 yr), plus other costs described in the BACT implementation procedure

3) Direct costs include Electrical (\$0.1/kw), plus other costs described in the BACT implementation procedure

4) Non Methane Hydrocarbon emissions reductions are based on 100% Recovery capturing the entire NMHC emissions for the base period, 2005 (0.7 tons)

5) SOx emissions reductions are based on 100% Recovery capturing the entire SOx emissions for the base period, 2005 (1.94 tons)

6) NOx, CO and PM are estimated using AP-42 Emissions Factors

Based on this analysis, MRC concludes that further expansion of the LOP flare recovery or installation of storage facilities are not feasible options to reduce flaring. MRC believes more effective ways to reduce flaring include training, reliability improvement, and careful planning including adjustment of refinery operations. These actions will continue to occur as a result of the refinery flare procedures described previously.

401.4.3 Recurrent Failures

There have been no recurrent failures in equipment routed to the LOP flare in the period since July 2005.

B. FLARE SYSTEM: DELAYED COKING AREA FLARE

BAAQMD Source No. 4201 (also known as Clean Fuels Flare)

I. SYSTEM DESCRIPTION (12-12-401.1)

Process units in the Delayed Coking Area are served by a dedicated flare system. A sketch of this flare system is provided in Figure 7. This system is comprised of collection headers, liquid knockout vessel(s), two recovery compressors, piping to route recovered gas to gas treaters, water seal vessel(s), the flare header proper, and the flare field¹². Piping provides sufficient flexibility to operate in various configurations, allowing continuous and reliable operation during turnarounds, inspection and maintenance activities. Technical details of the system are provided in Appendix B.

Process units in the Delayed Coking Area that are served by the DCU flare system include the Delayed Coker, Isomerization, Distillate and Heavy Gasoline Hydrotreaters, the Cat Gas Depentanizer, Sulfur Recovery Unit 4 and Hydrogen Plant 3.

Capacity of the two existing DCU flare recovery compressors is approximately 4 million standard cubic feet per day (MMSCFD) each, for a total of 8 MMSCFD. Typical header gas flow, in the absence of relief events or unusual operations, is around 2 MMSCFD – well within the capacity of one compressor. Since both compressors are normally in operation except during maintenance when one is out of service, there is typically about 6 MMSCFD reserve capacity available to recover unexpected flows during relief events, or increased vent flows associated with planned and unplanned events. When one of the two flare recovery compressors is out of service for maintenance, the compressor remaining in service is able to recover the routine flare header flow.

The ability to take one compressor out of service for routine maintenance without flaring provides the ability for sufficient maintenance to ensure reliable compressor operation. Only one of the two compressors is scheduled for planned maintenance at any one time. Typical preventative maintenance involves a 'minor' (process-side) overhaul or a 'major' (process-side + running gear) overhaul. A process-side overhaul typically includes: replacing suction and discharge valves, overhauling suction valve unloaders, replacing piston rod packing, replacing piston rings and rider bands, and inspecting piston rods and cylinder liners. A running gear overhaul typically includes: inspecting crossheads and connecting rods, replacing connecting rod bushings and bearings, inspecting crankshaft and main bearings, cleaning lube oil system, and miscellaneous work on instrumentation and auxiliary equipment.

As discussed in Section 3, MRC's maintenance program utilizes a risk-based approach to balance the frequency for preventative maintenance of a flare compressor to ensure reliable operation with the risk of flaring due to operation with only one compressor while the other is being maintained. Past maintenance history and current condition are used to evaluate the risk of operation beyond 'typical' overhaul intervals. Compressor operation is monitored closely by both operations and maintenance to ensure the highest probability of reliable operation. Typical variables that are monitored are suction and discharge pressures and temperatures, process flow, lube oil pressure

¹² The Delayed Coking Area flare uses an array of 160 separate tips instead of a single stack. This design allows smokeless combustion using very low rates of steam.

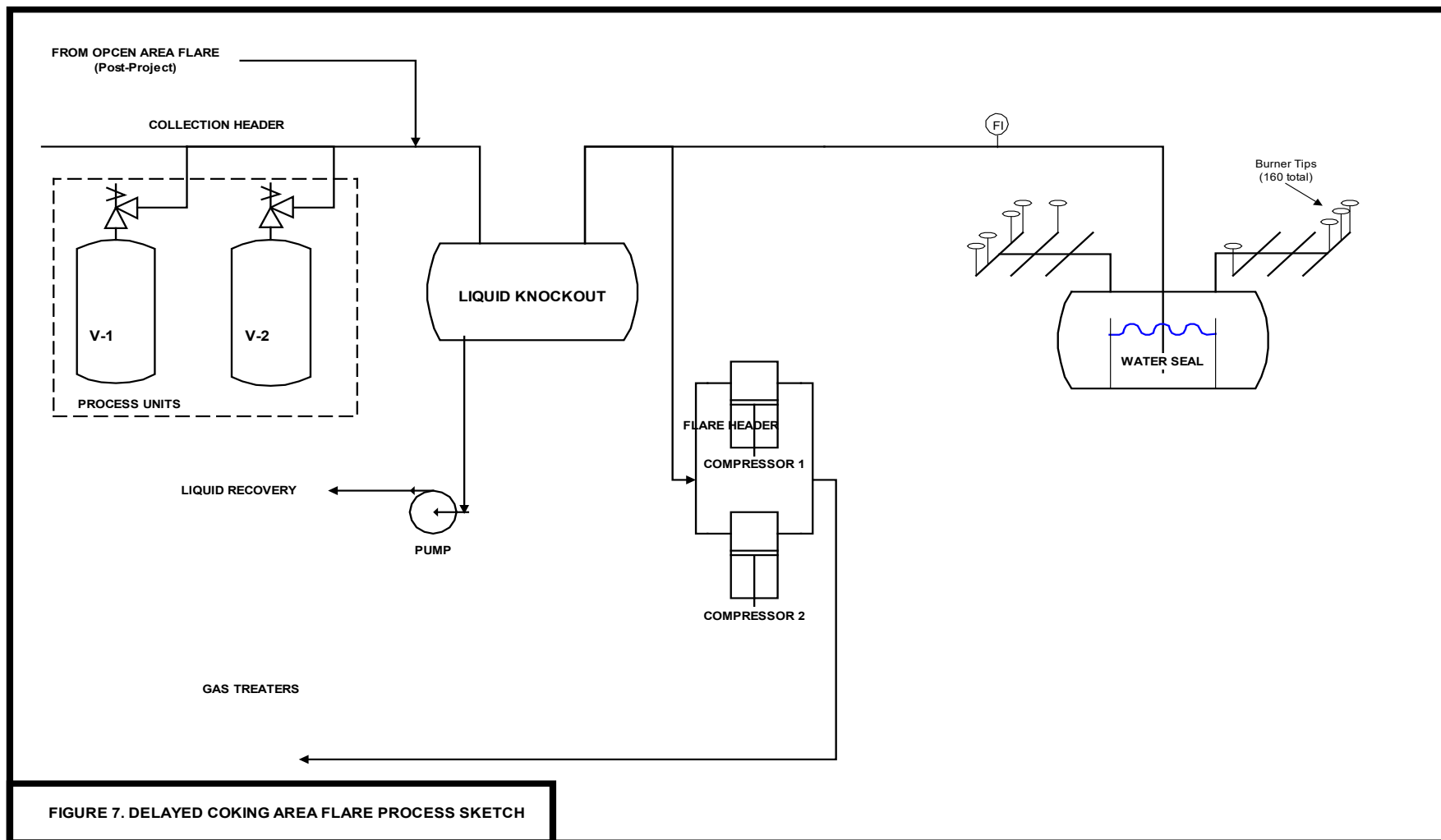

and temperature, and vibration.

Recovered gas from the Delayed Coking and OPCEN HC flare headers is treated to remove sulfur in the Vent Gas Treater in Delayed Coking. Sufficient capacity is available in this gas treater for the incremental flow (up to the total capacity of about 8 MMSCFD). From the Vent Gas Treater, the treated gases may be routed to the refinery fuel gas blend drum for use as fuel in combustion devices throughout the refinery. In addition, the treated gas from the Vent Gas Treater may be used as feed to Hydrogen Plants 2 and 3. Having the option of using the treated fuel gas as feed to the hydrogen plants or fuel for heaters throughout the refinery increases the flexibility of the fuel gas system, reducing the potential for fuel gas imbalance that may cause flaring.

II. HISTORICAL FLARING REVIEW

Summary

DCU flare activity 7/1/20 – 6/30/21

There were no flaring events during the 12-month period of this update requiring a Causal Analysis. Eight small flaring events occurred during this 12-month period. All but one event was less than 15 minutes. These events were reviewed and shared across the refinery for awareness.

DCU flare activity 7/1/19 – 6/30/20

There was one flaring event during the 12-month period of this update requiring a Causal Analysis. The reportable flaring event occurred on October 14, 2019 and was a result of an earthquake that triggered a safety system that shuts down a compressor in the Delayed Coking area. As a result, vent gas was sent to the DCU flare.

Seven small flaring events occurred during this 12-month period. These events were reviewed and shared across the refinery for awareness.

DCU flare activity 7/1/18 – 6/30/19

There was one flaring event requiring Causal Analysis on the DCU flare during this 12-month period. On July 30, 2018, the DCU wet gas compressor shut down during unit start up activity as a result of excess liquid in the overhead accumulator. Based on the investigation, a preventive measure was put in place where the DCU start-up procedure was reviewed and language modified to provide guidance on use of other instrumentation to differentiate between a liquid full and vapor full condition. This event also resulted in a small amount of flaring at the OPCEN hydrocarbon flare.

There were 4 small events that were reported on the monthly flare reports. None of the minor events were planned. One occurred as a result of overpressure at one unit. The small flaring events that occurred during the year were reviewed and shared across the refinery for awareness.

DCU flare activity 7/1/17 – 6/30/18

There were three flaring events requiring Causal Analysis on the DCU flare during this 12-month period. The first reportable flaring event occurred on 7/24 due to the shutdown of DHT recycle compressor. This resulted in an emergency depressuring of the unit to the flare. The cause of the failure was suspected to be the result of corrosion on the actuating mechanism for the switch. Prevention measures are focused on including additional testing procedures for the shutdown switch.

The second reportable flaring event occurred on 12/21 when an electrical breaker tripped open and caused the wet gas compressor (WGC) to shut down. The wet gas compressor is the primary means of pressure control in the column, therefore to protect the system from overpressuring the vent gas was relieved to flare. The investigation determined the trip was likely the result of a nuisance trip. The prevention measures include better balancing load share and providing alternative external power.

The third reportable flaring event occurred on 3/16 due to a pumparound exchanger leaker causing an emergency unit shut down. The cause of the leak was suspected to be a combination of pressure and/or thermal cycling of the exchanger resulting from a charge pump trip while a second pump was out of service for maintenance. The prevention measures are focused on scheduling of maintenance activities to help minimize when redundant systems are not available and thereby reduce flaring risk.

The six small flaring events that occurred during the year were reviewed and shared across the refinery for awareness. Two of the events were caused by unit shutdown and startup activity for turnaround, one was caused by an instrumentation cutover issue, two were caused by issues associated with the flare gas compressors and one was caused by sending wet steam to the WGC. Operations aggressively responded to stop all flaring as quickly and safely as possible.

DCU flare activity: 7/1/16 – 6/30/17

There were no flaring events requiring Causal Analysis for events greater 0.5 MMSCF or 500 lbs of SO₂ on the DCU flare between 7/1/16 and 6/30/17. There were 2 small events that were reported on the monthly flare reports. Neither of the 2 minor events were planned. One of the events lasted 1 minute and the second lasted 5 minutes. Both were aggressively responded to by operations to stop the flaring as quickly as safely possible. The small flaring events that occurred during the year were reviewed and shared across the refinery for awareness.

DCU flare activity: 7/1/15 – 6/30/16

There were no flaring events requiring Causal Analysis for events greater 0.5 MMSCF or 500 lbs of SO₂ on the DCU flare between 7/1/15 and 6/30/16. There were 4 small events that were reported on the monthly flare reports. None of the 4 minor events were planned.

The small flaring events that occurred during the year were reviewed and shared across the refinery for awareness. None of the events lasted more than 15 minutes and all were aggressively responded to by operations to stop the flaring as quickly as safely possible.

DCU flare activity: 7/1/14 – 6/30/15

There were no flaring events requiring Causal Analysis for events greater 0.5 MMSCF or 500 lbs of SO₂ on the DCU flare between 7/1/14 and 6/30/15. There were 5 small events that were reported on the monthly flare reports. None of the 5 minor events were planned.

The five small flaring events that occurred during the year were reviewed and shared across the refinery for awareness. Of the five events, 2 were due to a slight overpressure of the flare header during the blowdown cycle on the coker resulting in less than 15 minutes of flaring, 1 was due to a pressure control valve failure resulting in 2 minutes of flaring and 2 occurred due to problems with the online flare vapor recovery compressor while the other compressor was out of service for annual overhaul. One of the problems with the online compressor was a failed oxygen sensor resulting in less than 5 minutes of flaring and the other was caused by a problem with the compressor lube oil pressure when the lube oil filter was replaced after maintenance. With all of these events, the flaring was stopped as quickly as safely possible.

DCU flare activity: 7/1/13 – 6/30/14

There were two flaring events requiring Causal Analysis for events greater 500 MSCF or 500 lbs of SO₂ on the DCU flare between 7/1/13 and 6/30/14 and 6 small events not requiring causal analysis that were reported on the monthly flare reports.

The first reportable flaring event occurred on 1/27/14 when the Delayed Coking Unit's wet gas compressor shut down due to a high level in the Main Fractionator Overhead Accumulator during a unit startup. The high level occurred due to the sudden increase in fractionator temperature due to reduced column reflux flow and pump-around flow. Prevention measures are being implemented to minimize flaring from this type of event.

The second reportable flaring event on the DCU flare occurred on 2/21/14 when emergency depressuring of the Distillate Hydrotreater Unit was activated due to a suspected leak on the unit when an operator noticed smoke rising from the air cooler deck where a new air cooler had been installed. Thorough inspection and pressure testing of the air coolers following the event did not find a leak. Among other things, the investigation looked into the coating that was applied to the air coolers and the temperature of the equipment at the time of the event but was not able to determine a definitive cause for the smoke. The amount of fire water applied to the equipment during the event may have removed evidence of extraneous material on the exterior of the equipment although there had been no report of that when the equipment was installed and initially inspected. MRC will continue to assure that the proper heat resistant coatings are applied to new equipment and that inspection of new equipment prior to operation is conducted to ensure the equipment is free of spills that could smoke when heated.

None of the 6 small events that occurred during this update period were planned. All except for one were less than 5 minutes and due to slight overpressure in the flare header during planned unit shutdown. One event occurred during testing on an emergency depressuring valve. The longest event occurred when one of the flare recovery compressors tripped on high oxygen while the other compressor was out of service for rebuild. The investigation determined that there was a problem with the oxygen analyzer.

DCU flare activity: 7/1/12 – 6/30/13

There was one flaring event requiring Causal Analysis for events greater 500 MSCF or 500 lbs of SO₂ on the DCU flare between 7/1/12 and 6/30/13 and 2 small events not requiring causal analysis that were reported on the monthly flare reports. The reportable flaring event occurred on 12/25/12 when the Distillates Hydrotreater Unit shut down suddenly on complete loss of power. The process

unit had to be depressured to the flare and shut down to a safe condition until the cause of the power outage could be determined. Investigation determined that the power was lost when a 12 KV feeder breaker tripped as the result of a ground fault. The ground fault was caused by the catastrophic failure of an insulator in the electrical switch. It was believed the insulator failed due to moisture in the switchgear.

Neither of the two small events that occurred during this update period were planned. Both occurred during depressuring of equipment that briefly exceeded the capacity of the flare gas recovery compressors. One event lasted 1 minute and the other was 7 minutes.

DCU flare activity: 7/1/11 – 6/30/12

There were no flaring events requiring causal analysis for events greater 500 MSCF or 500 lbs of SO₂ on the DCU flare between 7/1/11 and 6/30/12 and 2 very small events not requiring causal analysis that were reported on the monthly flare reports. Neither of the two small events was planned. One of the events occurred due to an upset in a hydrogen plant resulting in 8 MSCF to the flare. The other event occurred during an upset in the Delayed Coker causing a slight pressure increase and a small 3 MSCF flaring event.

DCU flare activity: 7/1/10 – 6/30/11

There were two flaring events requiring causal analysis investigation on the DCU flare during this period and four small events that did not require investigation but were included on the monthly flare reports.

The first reportable flaring event during this period occurred on 9/9/10 and was caused by wet steam. The wet steam caused surging in the wet gas compressor resulting in overpressure of the Delayed Coker main fractionator which relieved into the flare system. The cause of the wet steam was due to low flow in a portion of the steam header which allowed condensation to occur. Prevention measures included adding a low flow alarm on this portion of the steam header and changes to the operator console to better display the steam balance.

The second reportable flaring event occurred on 2/24/11 when the Distillates Hydrotreater shut down due to activation of an emergency shutdown system. The shutdown system activated when a level transmitter on a column failed high, tripping the shutdown system. The level transmitter will be replaced with a smart digital transmitter that has the electronics to detect a failure status so the operator will know that the transmitter has failed and can take action to have it replaced rather than automatically activating the shutdown system.

None of the flaring events, including the four small events were planned. Refinery flare procedures were all followed and the flaring was minimized and stopped as quickly as possible. Two of the small events were only 2 minutes long and the longest of the four lasted 38 minutes when the hydrogen plant owned and operated by a third party contractor tripped offline due to equipment problems. Their equipment is tied into the DCU flare.

DCU flare activity: 7/1/09 – 6/30/10

There were no flaring events requiring causal analysis (events greater 0.5 MMSCF or 500 lbs of SO₂) on the DCU flare between 7/1/09 and 6/30/10 and approximately 3 minor events not requiring causal analysis that were reported on the monthly flare reports. Each of these 3 flaring events was unplanned and all were stopped as quickly as possible, none of them lasting more than 15 minutes.

DCU flare activity: 6/1/08 – 6/30/09

There were two flaring events requiring causal analysis (events greater 0.5 MMSCF or 500 lbs of SO₂) on the DCU flare between 6/1/08 and 6/30/09 and approximately 11 minor events not requiring causal analysis that were reported on the monthly flare reports.

The two reportable flaring events occurred in July 2008 and May 2009. Both were unplanned events due to process upset or malfunction of equipment. These flare events were investigated and prevention measures identified and implemented (see Part 3 of this Section – Reductions Previously Realized). The results from the investigations into these events were reported to the District in Causal Analysis reports. None of the flaring that occurred, including the minor events, was planned. All flaring, when it occurred, was minimized and stopped as quickly as possible.

DCU flare activity: 1/1/06 – 6/1/08

There were three flaring events requiring causal analysis (events greater 0.5 MMSCF or 500 lbs of SO₂) on the DCU flare between 1/1/06 and 6/1/08 and approximately 23 minor events that were reported on the monthly flare reports.

The three reportable flaring events occurred in October 2007, March 2008 and May 2008. All were unplanned events due to process upset or malfunction of equipment. These flare events were investigated and prevention measures identified and implemented (see Part 3 of this Section – Reductions Previously Realized). The results of the investigations into these events were reported to the District in Causal Analysis reports. None of the flaring that occurred, including the minor events, was planned. All flaring, when it occurred, was minimized and stopped as quickly as possible.

Beginning in November 2006 with the adoption of the Flare Procedures described in the Common Measures Section, pertinent information, when available, was captured immediately after a flaring event to determine the cause of any flaring and what could be done to prevent it from happening again. Total emissions from all flaring during this 30-month period were: 0.17 tons of methane, 0.45 tons of non-methane hydrocarbon and 4.19 tons of SO₂. Figure 2008-2 presents a comparison of the average emissions per large reportable events over this time period vs. the average emissions per small event for the DCU Flare. This figure shows that small events contributed < 6% of the emissions of a large event. Figure 2008-2 reinforces the appropriateness of the causal analysis trigger of 0.5 MMSCF/ 500 lbs SO₂ to ensure the resources to conduct a Causal Analysis are most effectively applied to address high emission events.

FIGURE 2008-2

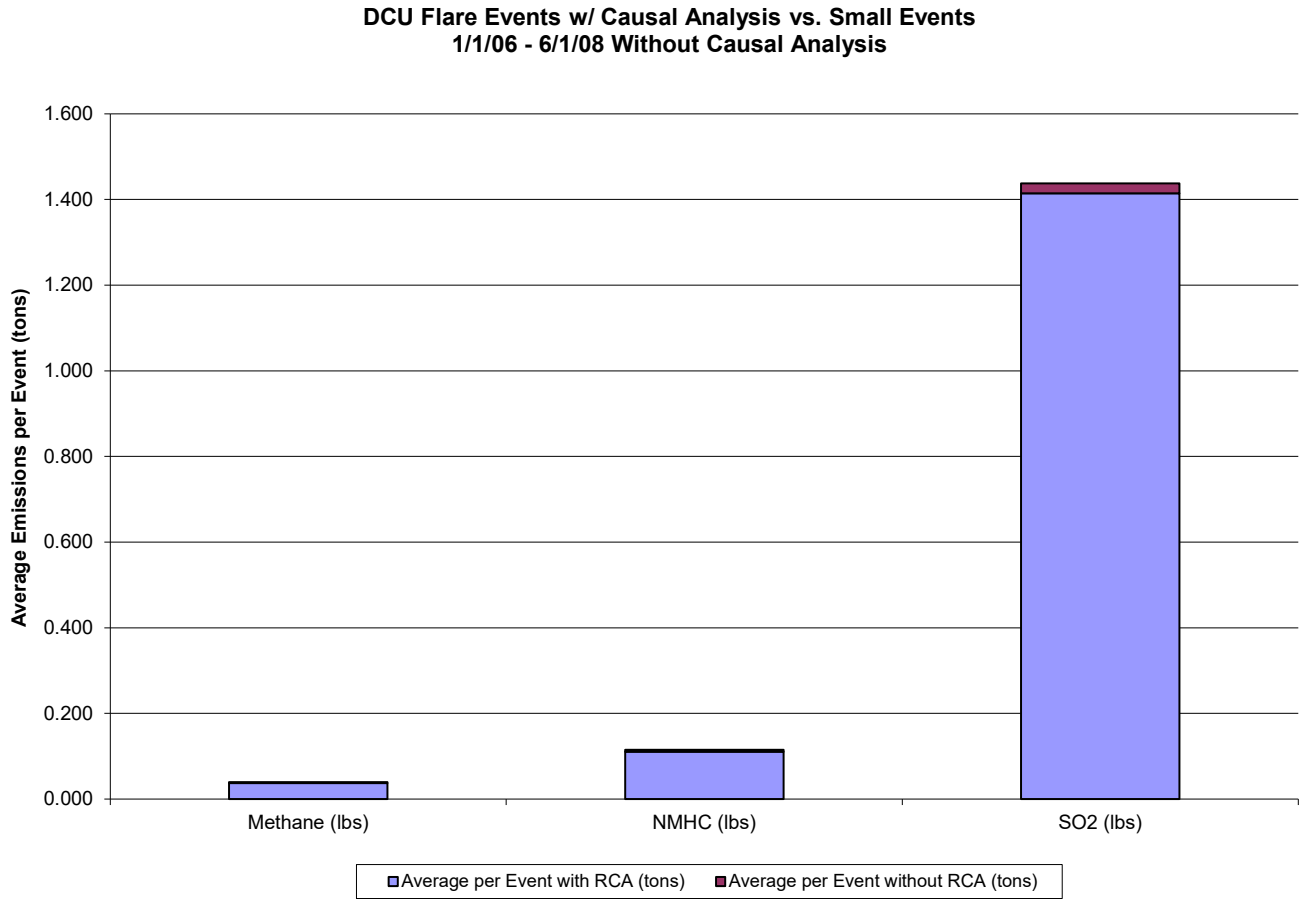

The DCU flare events that occurred from 1/1/06 – 6/1/08 were categorized by probable cause in Figure 2008-3. None of the flaring was planned. Most of the events were < 10 minutes long. The majority of the events were caused by process upset, mechanical failure or were unplanned during startup and shutdowns.

FIGURE 2008 - 3

**Probable Cause of Flaring on DCU Flare 1/1/06-6/1/08
26 Events**

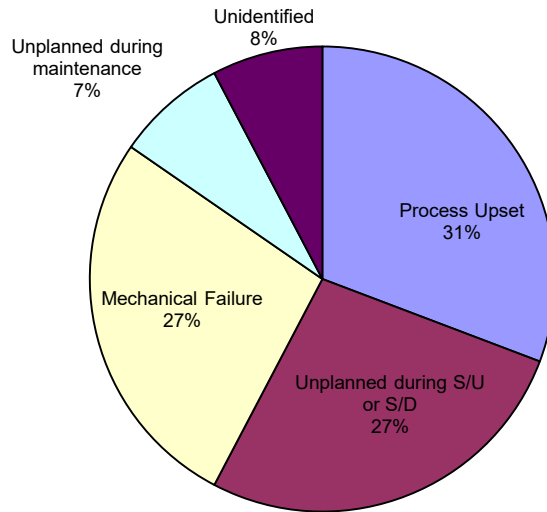

DCU flare activity: 1/1/04 – 1/1/06:

There were no reportable flare events (flaring greater 0.5 MMSCF) for the Delayed Coking Area flare during the two-year period between January 2004 and January 2006. Minor flare activity during this period accounted for less than 0.04% of permitted refinery emissions of non-methane hydrocarbon. Efficiency of the existing flare gas recovery system exceeds 99.90% for non-emergency flaring.

There were 25 occasions where minor flaring occurred at the DCU Flare during the two-year period from 2004 - 2006. Most activity lasted for less than 20 minutes, and typically less than 10 minutes. Total emissions of non-methane hydrocarbon during this period were less than 0.8 pounds per day. The average annual emissions over the two-year period were approximately 0.13 ton/year.

Discussion: Historical flaring at the Delayed Coking area flare was reviewed to identify opportunities for potential mitigation. As a condition of MRC’s Clean Fuels permit (Title V permit condition 12271), it has been necessary to track these events since the flare start-up and include the flare emissions in the total emissions under the Clean Fuels emissions cap. Accuracy of the measurements improved significantly once flare flow monitoring and sampling equipment was provided. For that reason, the data review based actual emissions on data collected between January 2004 and December 2005. Reports from 2000 through early 2005 were used to develop the distribution of the causes of flaring.

Flaring prior to January 2004. Review of flare events prior to January 2004 provided little usable information. Without flow meters, neither durations nor volumes may be determined with accuracy approaching that with flowmeters installed. In many cases, even the proximate cause of flaring could not be reliably determined due to the limited documentation and time elapsed since the event. With these qualifications, a breakdown for general cause of Delayed Coking flare events for the previous five years is depicted in Figure 8. A description of the various categories listed is provided below:

Process Upset: Flaring attributed to Process Upsets.

Mechanical Failure: Flaring attributed to mechanical or instrument failure, including Flare Gas Recovery compressors and trips of Hydrogen Plant #3.

SU/SD: Flaring attributed to Process Start-Up and Shutdowns. Flare events due to Startup and Shutdown have generally been eliminated in recent years by procedural revisions. In some cases this includes use of temporary facilities for selected activities.

Process constraint addressed by procedure: This category identifies events where reevaluating process and equipment constraints has allowed procedure revisions to reduce or eliminate flaring.

Flaring during 2005. The highest quality data are available for the period from January 2005 to January 2006. Data is available during this period from flare flow meters and monthly BAAQMD flare reporting. Available data for flare event volumes and durations are provided in Figures 9 through 11 below.

Figure 9 depicts the amount of material flared during the reported incidents of flare activity in 2005. All flaring was below 500,000 scf. Approximately 70% of the incidents of reported flaring involved volumes of gas of 50,000 SCF or less. All were below 300,000 standard cubic feet.

Figure 10 depicts the average rates of flow to the flare for events occurring in 2005. These data indicate that approximately 80% of the flare events had event-average flow rates less than 3 million standard cubic feet per day. Actual instantaneous rates comprising the average are generally higher – often significantly – than these average rates.

Based on the reliable data collected since initiation of flare gas flowrate monitoring, non-methane hydrocarbon emissions from the Delayed Coking area flare during 2004 and 2005 corresponded to about 0.14 ton.

Figure 11 depicts the distribution of flare event durations for 2005 where these data are available. 50% of the events lasted less than 30 minutes. This is consistent with other data characterizing the bulk of flare events being very brief.

**Figure 9. Delayed Coking Area Flare Gas Volumes
(2005)**

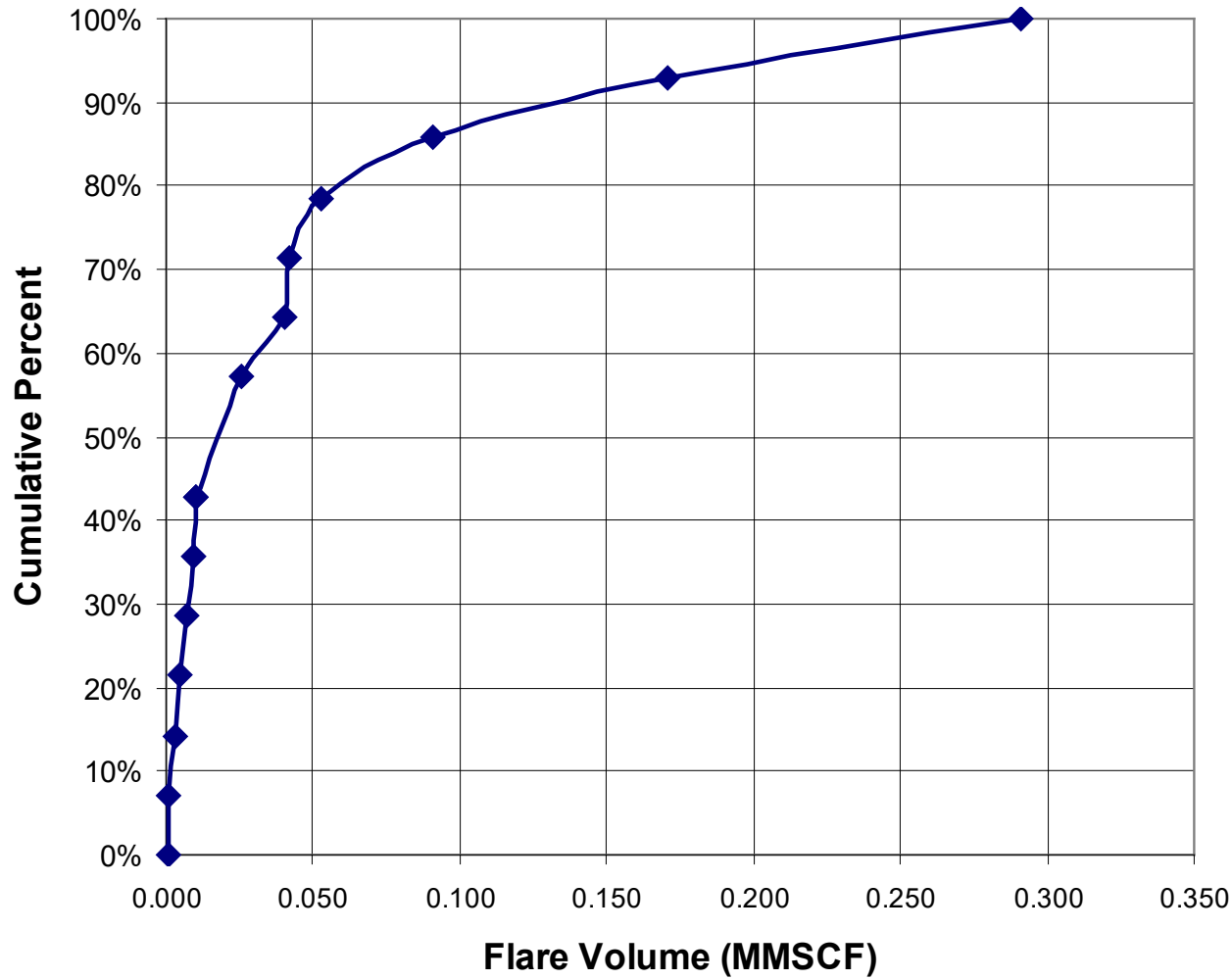

**Figure 10. Delayed Coking Area Flare Gas Flow Rates
(2005)**

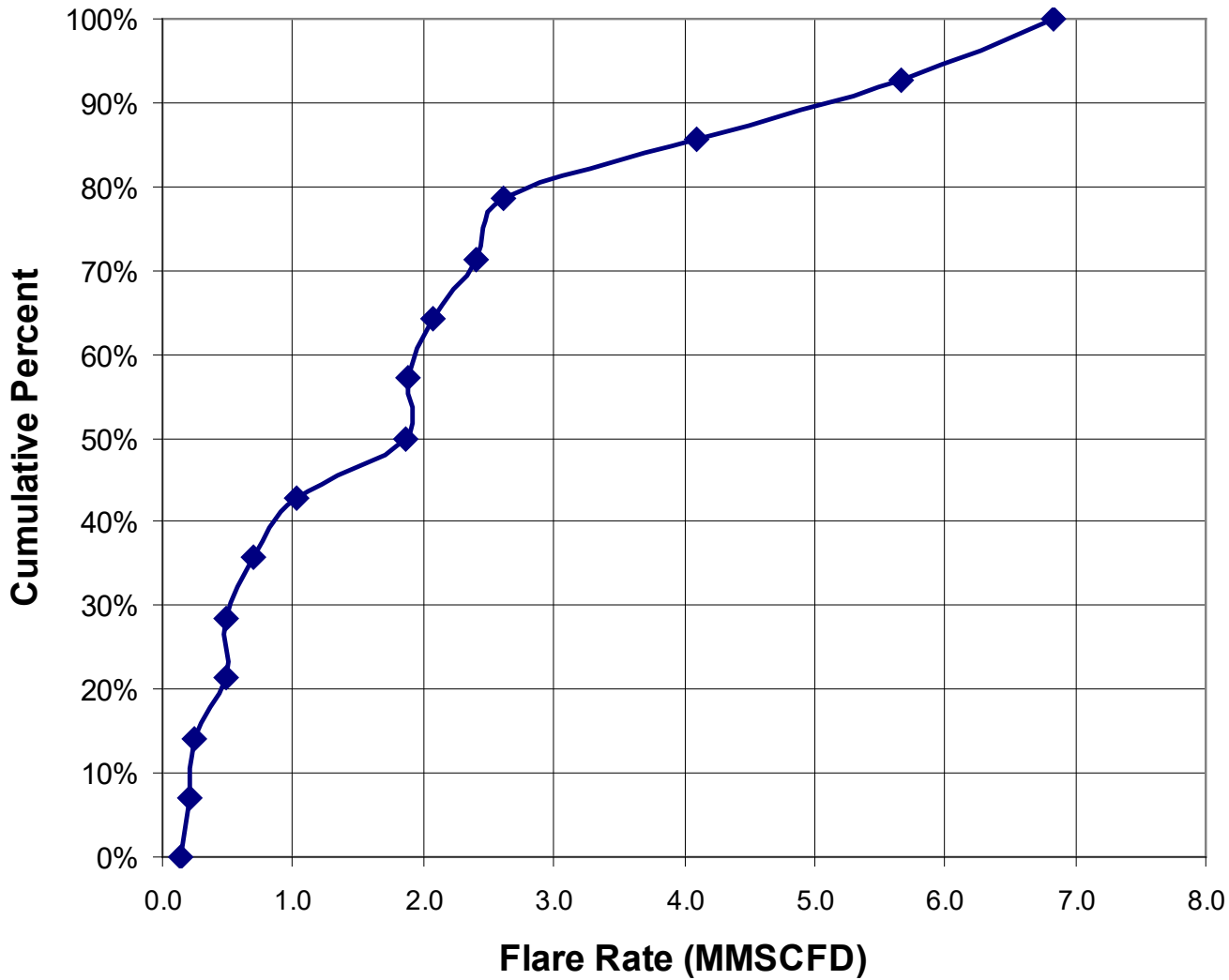

**Figure 11. Delayed Coking Area Flare Event Durations
(2005)**

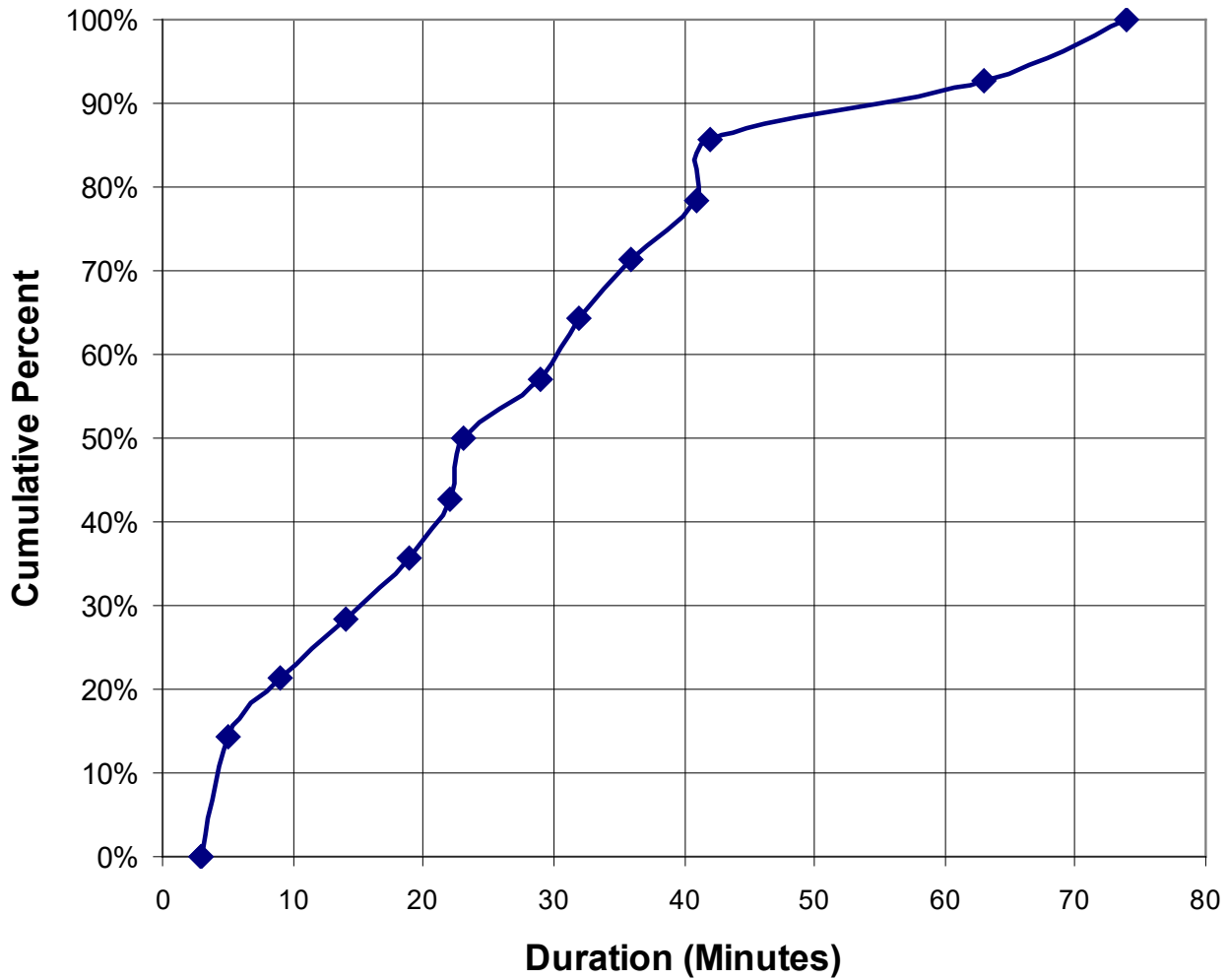

III. REDUCTIONS PREVIOUSLY REALIZED (12-12-401.2)

Equipment, processes and procedures installed or implemented to reduce flaring are listed below.

HARDWARE AND PROCESS REVISIONS

A variety of hardware modifications, and operational and procedural changes have been made in the Delayed Coking Area to reduce flaring.

- (A) The single greatest reduction in flaring accompanied steps to improve reliability of the DHT recycle compressor. Prior to this work, the DHT was depressured to the flare when its recycle compressor stopped for any reason¹³. This occurred approximately once or twice each year. Hardware and process changes were implemented in 2001 following an extensive study to improve compressor reliability. The compressor currently meets the three-year run premise of the DHT. Hardware and Process revisions included;
 - i) Revisions to design of compressor seals.
 - ii) Addition of a dedicated seal gas coalescer and seal instrumentation revisions. Installed cost of this hardware exceeded \$700,000.
 - iii) Removing DEA from the upstream contactor to prevent DEA reaching compressor seals.
- (B) A flaring event occurred on the DCU flare on March 6, 2008 when the vibration-monitoring module failed on the DCU wet gas compressor causing the compressor to trip. The vibration module was replaced in May 2008 and the results of the incident were communicated with appropriate operating and maintenance personnel. The module manufacturer completed a detailed failure analysis on the component on June 30, 2008 and as a result replaced some faulty relays.
- (C) A flaring event occurred on July 1, 2008 on the DCU flare when both of the flare vapor recovery compressors were out of service. One of the two flare compressors had been shut down for planned maintenance when the second compressor had to be shut down due to salt and hydrocarbon plugging of its 3rd stage suction inlet valve. The investigation into the plugging revealed that the on-line performance monitoring could be improved to provide earlier indication of salt/hydrocarbon build-up so that pro-active maintenance could take place to ensure reliable operation of both compressors. The on-line performance-monitoring program was expanded to evaluate process parameters such as individual stage suction and discharge pressures and temperatures for the compressors rather than solely the machine mechanical indicators such as vibration. Limits were set on critical flare compressor properties in the Operations' electronic daily field data collection system. These flagged points are sent by operations to the maintenance coordinator for appropriate action. This prevention measure was implemented in July 2008.
- (D) A flaring event occurred on May 20, 2009 when the DCU wet gas compressor shut down due to failure of a heat exchanger. The failure of the heat exchanger resulted in liquid carryover to the wet gas compressor which caused the compressor to shut down. The heat exchanger head where the leak occurred was wire wrapped and the bolts tightened to prevent further leaks. This prevention measure was completed May 20, 2009. An additional prevention measure to modify facilities to improve liquid removal capability from the lines to the wet gas compressor was completed by June 30 2010. This prevention measure was

¹³ The DHT (Distillate Hydrotreater (DHT) is a 2,000# hydrotreater. For process safety, this unit is automatically depressured to the flare system when recycle hydrogen stops for any reason. The high flow and temperatures of hydrogen to the flare during emergency depressuring make its recovery infeasible.

originally scheduled for completion by December 31, 2009 but additional time was necessary for complete evaluation of the technical issues associated with this change which delayed full implementation until June 2010.

- (E) A flaring event occurred on 9/9/10 when condensation in the steam system resulted in overpressure in the Delayed Coker main fractionator column. The wet steam was caused by low flow in a portion of the steam header. To reduce the likelihood of wet steam in the future the following prevention measures were both implemented in November 2010:
 - i) A minimum steam flow alarm was established on the Utilities Operator console
 - ii) The Utilities Operator console display was updated to better represent the steam system balance.
- (F) A flaring event occurred on 2/24/11 when the DHT emergency shutdown system activated due to a level transmitter that failed high. The level transmitter was replaced with a smart digital transmitter that was programmed to transmit a failure status to the DHT Board operator so action can be taken to repair it. The project was complete in December 2011.
- (G) A flaring event occurred on 1/27/14 when a high level in the DCU main fractionator overhead accumulator resulted during startup. A high level override was installed on the DCU Main Fractionator Overhead Accumulator to automatically increase the reflux flow rate in the event of an elevated level in the accumulator. This work was complete in February 2015.
- (H) A flaring event occurred on December 21, 2017 when an electrical breaker tripped open causing the wet gas compressor to shut down. To reduce the likelihood of a similar event, the following prevention measures were implemented by February 2018:
 - i) Switched loads to MCC-298 to ensure a more balanced load share so that the current is above a 20% threshold.
 - ii) Provided an external power supply for the trip unit power on MCC-298A.
 - iii) Provided external power supply for MCC-297A, MCC-297B and MCC-298B.

PROCEDURAL REVISIONS

The Delayed Coking Area flare header is provided with vapor recovery. Operating personnel have extensive experience managing background flare header traffic within the capacity limits of the compressors. These activities include managing startups, shutdowns, vessel depressuring and maintenance.

- (A) Occasionally, only one of the two Delayed Coking flare recovery compressors will be operating due to either planned maintenance or equipment breakdown. An operating procedure for switching coke drums when only one flare gas recovery compressor is online was developed in March 2004. Previously, entering the “blow-down” phase of the drum switch could create load requirements greater than the one available recovery compressor could consistently meet. Now, drum-stripping intervals have been increased to assure the vented vapors are reliably within the capacity of one machine. This procedure was adopted to ensure the load requirements during a drum switch are within the capacity of a single flare gas recovery compressor and is independent of which compressor is unavailable.
- (B) Reliability of the cooling water supply in the Delayed Coking area was improved in 2004 by modifying procedures to operate with two cooling water supply pumps where conditions allow. This increases the reliability of overhead condensing on the DCU Main Fractionator and its Wet Gas Compressor. When the wet gas compressor shuts down for any reason,

flaring will occur and the volume and temperature of vented gas far exceeds the capacity of any reasonable flare gas recovery compressor.

- (C) The Environmental Impacts assessment practice for turnaround and maintenance work has been in place for several years. Prior to each turnaround and major maintenance block, including the related startups and shutdowns, the operating department and turnaround group develop specific plans to minimize environmental impacts. The Operating Department and Turnaround groups develop the plans with input from the Planning Group and Environmental Affairs. Status and expected impacts are shared across the refinery before and during the turnaround. The overall environmental performance is reviewed after the turnaround to develop “lessons learned” for subsequent turnarounds. This practice is formalized in the Maintenance/Turnaround procedure (C(F)-21) described previously.
- (D) As the result of a flaring event that occurred on the DCU flare on October 7, 2007, MRC updated the DCU startup procedure in November 2007 to ensure that an operator is on hand to manage the liquid levels associated with the wet gas compressor during the liquid surge period. Learnings from the incident were communicated with operating personnel. Training materials and operating procedures were improved to clarify the most effective means of removal of liquid from the compressor suction line. These changes were completed by April 2008.
- (E) As a result of the flaring event that occurred at the DCU flare on May 8, 2008, two specific areas for improved training were identified. The training areas included specific training in identification of feed line submersion and high level prevention and recovery. The training material was presented to operations in May 2008. In addition, an event summary was added to the sustainable learning database and the Ensure Safe Production documentation for fractionator level indication was updated. Both of these items were completed by October 1, 2008. An additional prevention measure was identified to develop a mass balance indicator graphic for the DCU Main Fractionator Operator Display Screen. The graphic provides additional visual indication that the column is filling. This prevention measure was completed in December 2009.
- (F) As a result of the flaring event that occurred on the DCU flare on July 8, 2008, the Operation Support Engineer for the flare generates a periodic health tracking report for the DC Flare system. The performance report is used to predict the future compressor maintenance schedule. This prevention measure was implemented in August 2008.
- (G) The quality assurance and control procedures for heat exchangers during maintenance outages were reviewed to ensure that lubrication and torquing are checked prior to startup to prevent leaks similar to what resulted in the 5/20/09 flaring event. This review was complete in July 2009.
- (H) Findings from the 5/20/09 flaring event were reviewed with operations to help reduce the potential for flaring due to liquid carryover to the wet gas compressor. The review was complete in July 2009.
- (I) Findings from the 9/9/10 flaring event due to wet steam were reviewed with appropriate operating personnel. The review was complete in November 2010.

- (J) The Utilities Department was given primary operational responsibility for the LOP-DCU steam balance. This procedural change will help prevent situations where the steam balance allows effective stagnation in a portion of the header resulting in condensation similar to what caused the 9/9/10 flaring event in the DCU due to wet steam. The operational responsibility transition was complete in November 2010.
- (K) A flaring event occurred on 12/25/12 due to the catastrophic failure of an insulator inside an electrical switch resulting in power loss to the DHT. As a result of the investigation into this event, the inspection frequency of similar switches was increased from a 6 year maintenance interval to the next opportunity. During the inspections all insulators showing signs of rust or moisture will be proactively replaced. The inspections were added to the turnaround schedules for the affected units. This item was complete in February 2013.
- (L) As a result of a flaring event that occurred on 1/27/14 due to a high liquid level in the DCU main fractionator overhead accumulator, pump startup training was refreshed with board and field operators. The additional training was complete in February 2015.
- (M) A flaring event occurred on 2/21/14 when the emergency depressuring switch was activated on the Distillate Hydrotreater when smoke was observed from a new air cooler that had just been installed. A leak was never found and the investigation could not identify the source of the observed smoke. MRC will continue our procedure of assuring the proper heat resistant coating on new equipment and inspection prior to installation to ensure the equipment does not have extraneous material on the exterior that could smoke on startup.
- (N) As a result of the flaring event that occurred on July 24, 2017, the DHT recycle gas compressor shutdown device input and output functionality testing procedure was reviewed and revised to include additional steps for inspection and function testing of the pushbutton shutdown switch. This prevention measure was completed in September 2017.
- (O) Findings from the March 16, 2018, flaring event were reviewed with operations to reduce the potential for flaring during certain maintenance activities such as one-charge pump operation. The review was complete in March 2018.
- (P) Based on the investigation of the July 30, 2019 event, the DCU start-up procedure was reviewed and language modified to provide guidance on use of other instrumentation to differentiate between a liquid full and vapor full condition.

IV. PLANNED REDUCTIONS (12-12-401.3)

HARDWARE AND PROCESS REVISIONS

In light of the historical flaring review, the analysis of potential mitigation measures provided in section 401.4.2 (below), and the effectiveness of the flare policy and procedures described previously, no further hardware or process revisions to reduce flaring are planned on the DCU flare at this time. The FMP will continue to be updated at least annually to include any planned revisions developed from the causal analysis of future flaring events.

PROCEDURAL REVISIONS

The four procedures described under the section Prevention Measures Common to All Flares, were implemented in 2006. These procedures help us continue to find ways to minimize and reduce flaring where possible, but it is impossible to quantify the expected reduction in flaring. Any reduction in flaring, no matter how small, eliminates the emissions that would have occurred due to the flaring, including the emissions of non-methane hydrocarbon and sulfur dioxide.

V. PREVENTION MEASURES (12-12-401.4)

401.4.1 Prevention Measures for Flaring due to planned Major Maintenance

Based on the historical review of flaring incidents, planned major maintenance is not a significant contributor to overall flaring due to careful review and planning prior to major maintenance. The shutdown and startup reviews resulting from the Maintenance/Turnaround procedure C(F)21 continue improve our ability to perform these planned activities without flaring. MRC is committed to continue this careful review and planning prior to planned major maintenance and expect to continue to perform turnarounds with little or no planned flaring. Therefore there is no predicted flaring resulting from planned major maintenance for which to evaluate prevention measures against. If during the maintenance planning and review MRC finds that planned flaring is required for some reason, all appropriate prevention measures will be considered and feasible measures will be implemented to reduce or eliminate the planned flaring.

In order to maintain equipment, it must be cleared of hydrocarbon before opening to the atmosphere for both safety and environmental reasons. Typically this is done by transferring as much of the hydrocarbon as possible to equipment that is still in service (e.g., pumping liquids to tankage) and then purging the equipment with nitrogen to a low-pressure closed system for recovery. The flare collection header is the lowest pressure closed system in the refinery. Careful planning to limit the depressuring/purge rate and to maintain an acceptable gas temperature and composition in the flare header can reduce the potential for flaring.

Although it may not be possible in all circumstances, MRC has found that planned depressuring and purging of equipment to the Delayed Coking flare header can typically be managed within the capacity and capability of the flare vapor recovery compressors for recovery of the gases to the refinery fuel gas system. Because of the robustness of the refinery fuel gas system described previously, the recovered purge gas from planned events can typically be absorbed in the fuel system without adverse impact on the refinery heaters and boilers.

There are occasions, typically due to equipment malfunction, when a decision has to be made to shut down a process unit or major piece of equipment within a period of hours or immediately. Although the refinery will review the impacts and attempt to minimize flaring as much as possible, it can be more difficult to eliminate flaring since it may not be possible in the limited time available to take actions to ensure the fuel gas system is balanced. Flaring due to these unexpected events will follow procedure C(F)20 and/or C(F)21 to ensure that flaring is minimized as much as possible and lessons learned are captured for the future. When these procedures are followed, any flaring is consistent with this FMP.

401.4.2 – Prevention Measures for flaring due to issues of gas quantity and quality including review of existing vent gas recovery capacity

Flaring due to gas quantity: Non-emergency flaring from the Delayed Coking Area flare during 2004 and 2005 amounted to less than 0.04% of permitted emissions of non-methane hydrocarbon. Efficiency of the existing flare gas recovery system is greater than 99.9%. Actual data for this flare is provided in figures 9 through 11. These data, together with knowledge of the various process

units and hardware served by the flare, provide no new alternative mitigations beyond those already presented for the LOP Area flare.¹⁴

Applying an analysis similar to that done on the LOP flare in the previous section, the capital and operating costs are essentially the same, but the lower frequency and volume of flare activity reduce the available emissions reductions. The reported 2005 NMHC emissions from the Delayed Coking flare were 0.16 tons (compared to 0.7 tons from the LOP flare). The combination of nearly identical costs and fewer emissions to eliminate produces significantly lower calculated cost-effectiveness. For the option where storage is not provided, the cost-effectiveness for NMHC emissions ranges between approximately \$40 Million and \$46 Million dollars per ton. For the option that includes storage, cost-effectiveness ranges between \$32 Million and \$35 Million dollars. (See Table 2 for additional details of these calculations). In either case, including emissions of greenhouse gases and non-methane hydrocarbon associated with producing the required electrical power to operate recovery compressors further decreases the cost-effectiveness.

The reported 2005 SO₂ emissions from the DC flare were 1.6 tons. The ratio of SO₂ emissions to NMHC emissions is 10:1 (1.6 tons of SO₂ and 0.16 tons of NMHC). Basing the cost effectiveness on SO₂ emission reductions instead of NMHC reductions improves the potential cost-effectiveness by a factor of 10. However, these prevention measures are still infeasible based on cost-effectiveness (\$3.2 MM – \$3.5 MM) for the option providing storage.

¹⁴ Refer to the LOP Area Flare section of this report for elaboration of the option and associated costs.

Table 2 Economic Justification for Additional Recovery Capacity at DCD Flare

A. No Gas Storage Provided

Additional Recovery Compressor Capacity (MMSCFD) ¹	Overall Recovery Efficiency (%)	Capital Cost (\$)	Annual Indirect Cost ² (\$/yr)	Annual Direct Cost ³ (\$/yr)	Combined Annual Cost ^{2,3} (\$/yr)	Emissions Reductions by Species (lbs/year)					Cost Effectiveness of Reductions (\$ Million/ton)				
						NMHC	SOx	NOx ⁶	CO ⁶	PM ⁶	NMHC ⁴	SOx ⁵	NOx	CO	PM
0	99.8800%	-	-	-	-	-	-	-	-	-	-	-	-	-	-
3	99.9129%	\$5,000,000	\$1,095,000	\$650,000	\$1,745,000	87.7	879.0	42.6	231.7	6.3	\$40	4.0	\$82	\$15	\$557
4	99.9191%	\$6,700,000	\$1,467,300	\$868,000	\$2,335,300	104.2	1044.6	50.6	275.4	7.4	\$45	4.5	\$92	\$17	\$628
5	99.9318%	\$8,300,000	\$1,817,700	\$1,082,000	\$2,899,700	138.2	1385.0	67.1	365.1	9.9	\$42	4.2	\$86	\$16	\$588
6	99.9365%	\$10,000,000	\$2,190,000	\$1,300,000	\$3,490,000	150.6	1510.0	73.2	398.1	10.8	\$46	4.6	\$95	\$18	\$649

B. 400,000 SCF Gas Storage Provided

Additional Recovery Compressor Capacity (MMSCFD) ¹	Overall Recovery Efficiency (%)	Capital Cost (\$)	Annual Indirect Cost ² (\$/yr)	Annual Direct Cost ³ (\$/yr)	Combined Annual Cost ^{2,3} (\$/yr)	Emissions Reductions by Species (lbs/year)					Cost Effectiveness of Reductions (\$ Million/ton)				
						NMHC	SOx	NOx ⁶	CO ⁶	PM ⁶	NMHC ⁴	SOx ⁵	NOx	CO	PM
0	99.8800%	-	-	-	-	-	-	-	-	-	-	-	-	-	-
3	99.9458%	\$10,000,000	\$2,190,000	\$850,000	\$3,040,000	175.4	1,758	85.2	463	12.5	\$35	\$3.5	\$71	\$13	\$485
4	99.9581%	\$11,700,000	\$2,562,300	\$1,068,000	\$3,630,300	208.4	2,089	101.2	551	14.9	\$35	\$3.5	\$72	\$13	\$488
5	99.9836%	\$13,300,000	\$2,912,700	\$1,282,000	\$4,194,700	276.3	2,770	134.2	730	19.7	\$30	\$3.0	\$63	\$11	\$425
6	99.9930%	\$15,000,000	\$3,285,000	\$1,500,000	\$4,785,000	301.2	3,020	146.3	796	21.5	\$32	\$3.2	\$65	\$12	\$445

¹) Capacity units are millions of standard cubic feet per day.

²) Indirect costs include Capital Recovery (10% interest over 10 yr), plus other costs described in the BACT implementation procedure

³) Direct costs include Electrical (\$0.1/kw), plus other costs described in the BACT implementation procedure

⁴) Non Methane Hydrocarbon emissions reductions are based on 100% Recovery capturing the entire NMHC emissions for the base period, 2005 (0.16 tons)

⁵) SOx emissions reductions are based on 100% Recovery capturing the entire SOx emissions for the base period, 2005 (1.6 tons)

⁶) NOx, CO and PM are estimated using AP-42 Emissions Factors

Flaring caused by gas quality: The reciprocating compressors used in Delayed Coking are fairly robust. Experience obtained over the past decade operating these compressors indicates they can effectively deliver their rated capacity over the range of normal operation and planned startup and shutdown activities – provided loads to the flare header are controlled. During relief events, high temperatures and/or the presence of condensable liquids may cause the compressors to stop or recycle discharge to suction, effectively stopping them from conveying flare header gas to the vent gas treaters.

Vent gas recovery capacity: The capacity of a flare gas recovery system is not more than the total installed nameplate capacity of the flare gas compressors. However, flare gas compressor capacity does not fully define the total capacity of the system. In order to recover flare gas for use in the fuel gas system, four criteria must be met. First, there must be sufficient flare gas compressor capacity. Second, the compressor capacity must be able to respond to the event so that it is available to recovery the increased flow. Third, there must be sufficient gas treating capacity. Finally there must either be available storage volume or a user (e.g., heater or boiler) with a need for the gas. If any of these conditions are not met, then the gas cannot be recovered into the fuel gas header.

MRC's vent gas recovery system does not include any dedicated capacity for storage of fuel gas or vent gas. On a continuous basis MRC optimizes the refinery fuel gas system of producers and consumers to maximize the capacity available for treatment and reuse of recovered gases. This is accomplished as described previously in the FMP under the Prevention Measures common to all the refinery flares. These Prevention Measures include:

- Adjusting the sources of fuel that are made up to the fuel gas system including purchased natural gas and propane. Having a range of streams available to provide pressure control minimizes the risk of fuel system pressures rising above target, which would otherwise result in flaring.
- Adjusting the operation of units that produce fuel gas range materials to reduce fuel gas production as much as possible (consistent with safe operation) to avoid flaring.
- Adjusting the refinery profile for consumption of fuel gas by ensuring the cogeneration unit is at its maximum capacity.
- Shifting rotating equipment to turbine drivers where feasible to increase steam consumption from steam generated in the fuel gas fired boilers. Several functions provided by rotating equipment in the refinery may be powered by either electricity or steam. This ability to shift the load between the off-site electrical grid and refinery steam boilers provides additional flexibility to balance the fuel system when there is an excess of fuel. In periods where the fuel supply is limited, motor drives maximize use of electrical power. When the refinery has an excess of fuel this equipment may be powered by steam. When the cause of flaring is the result of a process unit upset or mechanical failure, changing between steam turbine and electrical motor drivers is may not be practical and must be evaluated on a case-by-case basis¹⁵.

¹⁵ The use of steam drivers is less energy efficient than electricity. Regular use of steam driven equipment is evaluated considering both the reliability benefits with the increased operating costs, higher water demand, and greater emissions associated with steam production. If there is a fuel gas imbalance (for whatever reason) that results in flaring of excess fuel gas and some of that excess gas can be shifted to produce more steam, MRC won't have to flare that amount of fuel gas. This is how shifting to steam-driven equipment can reduce flaring in some circumstances.

Procedure C(F)22 is in place to help manage the fuel system balance during periods of flaring.

The total gas scrubbing capacity is an integral part of the refinery fuel gas management system. The capacity available for recovered vent gas scrubbing will vary depending on the balance between fuel gas production and consumption; it will vary both on a seasonal basis and during the course of the day. Sufficient capacity can be made available at the Delayed Coking treaters for the incremental flow up to the total capacity of both flare recovery compressors.

Delayed Coking flare gas recovery system capacity:

Total Delayed Coking flare gas recovery capacity = 8 MMSCFD

Total DC flare gas storage capacity = 0 SCF

DC fuel gas treating capacity- can match recovery capacity

For the period from 1/1/05 through 6/1/08, efficiency of the existing flare gas recovery system for the DCU flare exceeded 99.9%.

401.4.3 Recurrent Failures

There have been no recurrent failures in equipment routed to the Delayed Coking flare in the period since July 2005.

C. FLARE SYSTEM: OPCEN HYDROCARBON FLARE

BAAQMD Source No. 1772

I. SYSTEM DESCRIPTION (12-12-401.1)

Process units in the OPCEN area are served by a dedicated flare system. This flare was modified by a project to provide flare vapor recovery. The vapor recovery project was operational in November 2006. A sketch of the flare system is provided in Figure 12. The OPCEN HC flare system is comprised of collection headers, a liquid knockout vessel, a water seal vessel, piping to flare gas recovery compressors and gas treating, the flare header proper, and the flare¹⁶. Additional details of the flare are provided in Appendix C.

The process units in the OPCEN area that are served by the OPCEN Hydrocarbon flare include the hydrocarbon streams from the Flexicoker (FXU), Hydrogen Plant 2, Sulfur Recovery Unit 3 and the Dimersol Unit.

Prior to November 2006, all flare gas generated in OPCEN was flared at the OPCEN hydrocarbon flare. Routine flare flow, excluding purges, was typically less than 0.2 MMSCFD. With the vapor recovery project in place, compressors in the Delayed Coking area recover this gas from the OPCEN flare header and route this gas to the Vent Gas Treater as described in the Delayed Coking Area Flare section of this report. These two compressors have a capacity of approximately 4 million standard cubic feet per day (MMSCFD) each. Typical combined flow of Delayed Coking Area vents and OPCEN flare header gas flow is around 2 MMSCFD – well within the capacity of one compressor. Since both compressors are normally in operation except during maintenance, MRC expects about 6 MMSCFD reserve capacity available to recover unexpected flows during relief events, or increased vent flows associated with planned and unplanned events. See Section 4.B for more information concerning the DCU Flare Recovery Compressors.

Recovered gas from OPCEN is treated to remove H₂S and routed to fuel and hydrogen plant feed along with the recovered gas from Delayed Coking. The normal routing for Delayed Coker Area recovered flare gas is the Vent Gas Treater. Sufficient capacity is available for the incremental flow (up to the total recovery compressor capacity of about 8 MMSCFD).

¹⁶ This figure includes the flare gas recovery system with the modification. Due to the need for a general shutdown of process units in the OPCEN area, the system was not operable in time for the August 1, 2006 original submittal of this plan. Post-project facilities are used as the basis for system description. However, the historical performance of this flare obviously provides little basis for evaluating mitigation options beyond the implemented flare gas recovery.

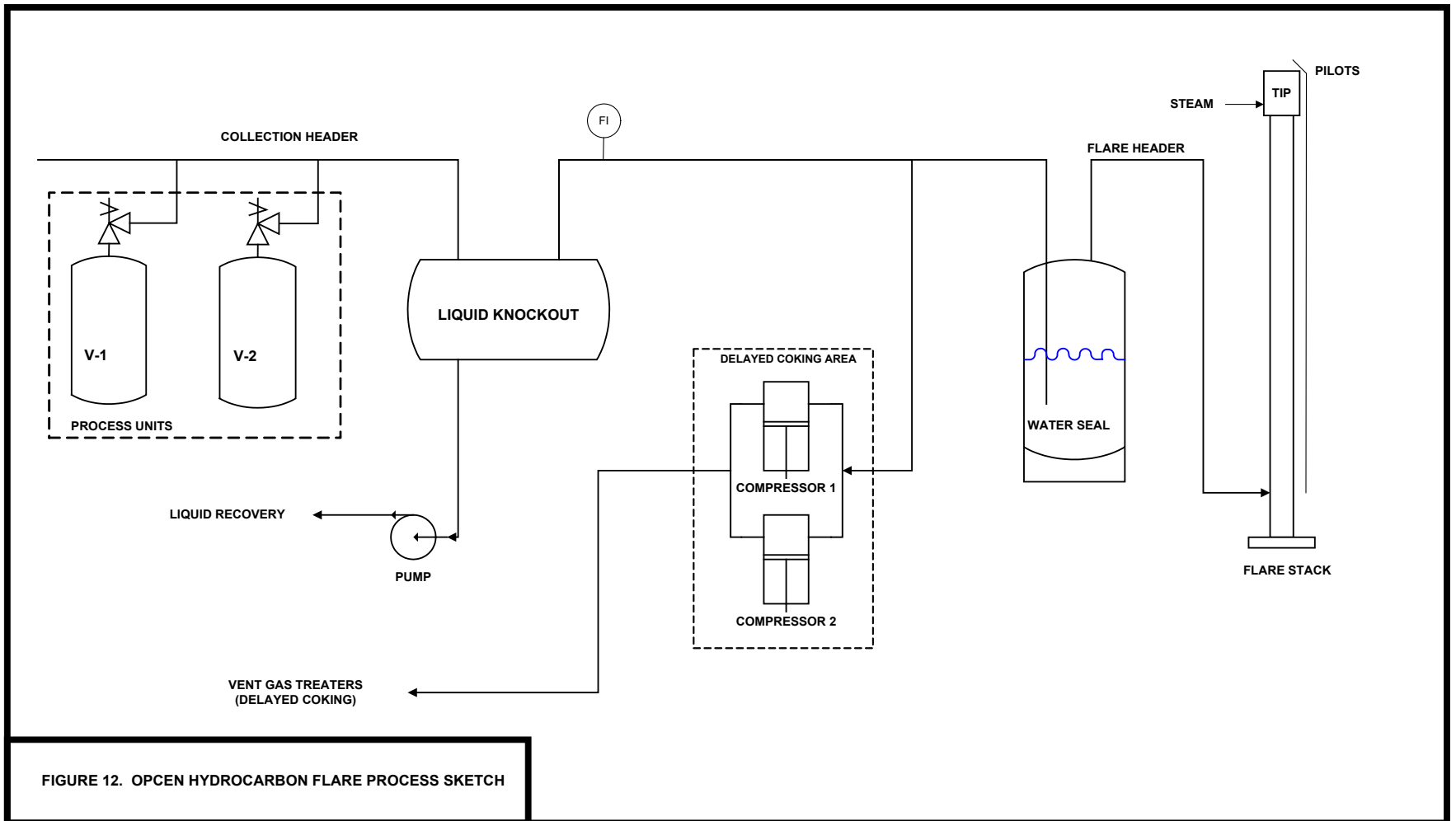

FIGURE 12. OPCEN HYDROCARBON FLARE PROCESS SKETCH

II. HISTORICAL FLARING REVIEW

Summary:

OPCEN HC flare activity 7/1/20 – 6/30/21

There were no flaring events on the OPCEN HC flare during this annual reporting period.

The figure below has been updated through 7/1/21 and shows the continued success of the implementation of the flare recovery project that occurred in 2006 on this flare.

Figure 2006-1 OPCEN HC Flare Monthly Flare Flows 1/1/04 - 7/1/21

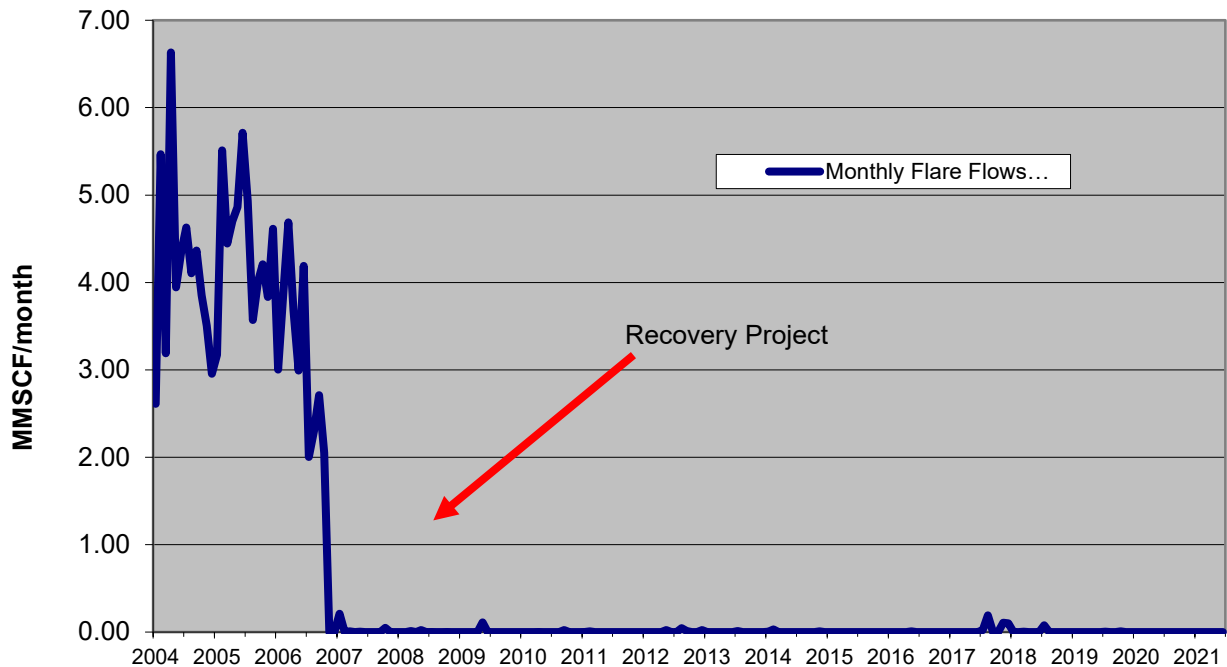

OPCEN HC flare activity 7/1/19 – 6/30/20

There were no reportable flaring events requiring a Causal Analysis on the OPCEN HC flare during this annual reporting period. The small flaring events that occurred during the year were reviewed, and emissions from the small events were reported on the monthly flare report.

OPCEN HC flare activity 7/1/18 – 6/30/19

There were no flaring events where the OPCEN HC flare experienced vent gas flow greater than 0.5 MMSCF or SO₂ emissions of greater than 500 lbs. However, as a result of the DCU flaring event that started on July 30 (described previously for the DCU flare), a small amount of flaring at the

OPCEN HC flare occurred due to the configuration and interconnection of the flare systems. There were no other small flaring events during the year.

OPCEN HC flare activity 7/1/17 – 6/30/18

There were no reportable flaring events requiring causal analysis on the OPCEN HC flare during this annual reporting period. The small flaring events that occurred during the year were reviewed and shared across the refinery for awareness. Two of these occurred as a result of the DHT compressor shut down and electrical breaker that triggered causal analysis reports due to flaring at the DCU flare. Another occurred as a result of the debutanizer leak that triggered a causal analysis report due to the flaring at the FXG flare. The emissions from the OPCEN flare were included in the reports for these events which are described in the DCU flare section. There was also flaring activity due to an unscheduled DSU unit shutdown.

OPCEN HC flare activity 7/1/16 – 6/30/17

There were no reportable flaring events requiring causal analysis on the OPCEN HC flare during this annual reporting period. There were no small flaring events on this flare during this time period.

OPCEN HC flare activity 7/1/14 – 6/30/15

There were no reportable flaring events requiring causal analysis on the OPCEN HC flare during this annual reporting period. There was one small unplanned flaring event that occurred during shutdown of the Flexicoker. The emissions from this small event were reported on the monthly flare report.

OPCEN HC flare activity 7/1/13 – 6/30/14

There were no reportable flaring events requiring causal analysis on the OPCEN HC flare during this 12-month period. There were three small unplanned flaring events during this time. Two of these occurred as a result of events that triggered causal analysis due to flaring on the DCU flare. The emissions from the OPCEN flare were included in the Causal Analysis Reports for these events which are described in the DCU flare section. The third small flaring event occurred during depressuring of a column in the Dimersol Unit. The depressuring rate was slowed to stop the flaring.

OPCEN HC flare activity 7/1/12 – 6/30/13

There were no reportable flaring events requiring causal analysis on the OPCEN HC flare during this 12-month period. There were three small unplanned flaring events during this time. Two of these occurred as a result of events that triggered Flexigas flaring. The emissions from the OPCEN flare were included in the Causal Analysis Reports for these events which are described in the Flexigas flare section.

OPCEN HC flare activity 7/1/11 – 6/30/12

There were no reportable flaring events requiring causal analysis on the OPCEN HC flare during this 12-month period and one small unplanned flaring episode that was reported on the monthly flare reports. The one event occurred during a hydrogen plant upset that also caused a small flaring event on the DCU flare.

OPCEN HC flare activity 7/1/10 – 6/30/11

There were no reportable flaring events requiring causal analysis on the OPCEN HC flare during this 12-month period and three very small flaring episodes that were all caused due to flaring on the DCU flare. When flaring occurs at the DCU flare, the OPCEN flare system is automatically isolated from the DCU flare recovery system. This can result in a small amount of flaring on the OPCEN HC flare. Figure 1 below has been updated through 7/1/11 and shows the continued success of the implementation of the flare recovery project in 2006.

OPCEN HC flare activity 7/1/09 – 6/30/10

There were no reportable flaring events requiring causal analysis on the OPCEN HC flare during this 12-month period. One minor event was reported on the monthly flare reports. This event was the result of an upset in the Flexicoker. The amount flared on the OPCEN HC flare was very small (< 50 SCF vs. a causal analysis trigger of 500 SCF). The implementation of the flare vapor recovery project on this flare continues to be a success.

OPCEN HC flare activity 6/1/08 – 6/30/09

There were no reportable flaring events requiring causal analysis on the OPCEN HC flare during this 13-month period. Three minor events were reported on the monthly flare reports. These three

events were the result of flaring events that occurred on the Delayed Coking flare that necessitated the isolation of the OPCEN units from the Delayed Coking flare recovery system.

OPCEN HC Flare Activity: 1/1/06 – 6/1/08

There were two flaring events requiring causal analysis (events greater 0.5 MMSCF or 500 lbs of SO₂) on the OPCEN HC flare between 1/1/06 and 6/1/08. After the flare recovery project was operational in November 2006, there were approximately 6 minor events that were reported on the monthly flare reports from 11/1/06 through 6/1/08. Prior to the startup of the recovery project, there was some flaring every day from this flare.

The two reportable flaring events that occurred since 1/1/06 were in August 2006 and January 2007. Both were unplanned events due to process upset or malfunction of equipment. These flare events were investigated and prevention measures identified and implemented (see Part 3 of this Section – Reductions Previously Realized). The results of the investigations into these events were reported to the District in Causal Analysis reports. None of the flaring that occurred, including the minor events after the flare recovery project was in place, was planned. All flaring, when it occurred, was minimized and stopped as quickly as possible.

Beginning in November 2006 with the adoption of the Flare Procedures described in the Common Measures Section, pertinent information, when available, was captured immediately after a flaring event to determine the cause of any flaring and what could be done to prevent it from happening again. Total emissions from all flaring during the 18-month period after the recovery project was implemented were: 0.04 tons of methane, 0.19 tons of non-methane hydrocarbon and 0.55 tons of SO₂.

The OPCEN HC flare events that occurred after the implementation of flare recovery from 11/1/06 – 6/1/08 were categorized by probable cause in Figure 2008-4. None of the flaring was planned. The cause of the events included process upset, mechanical failure or were unplanned during maintenance or startup and shutdown.

FIGURE 2008-4

OPCEN HC Flare- Cause of Flaring 11/1/06 - 6/1/08
7 Events

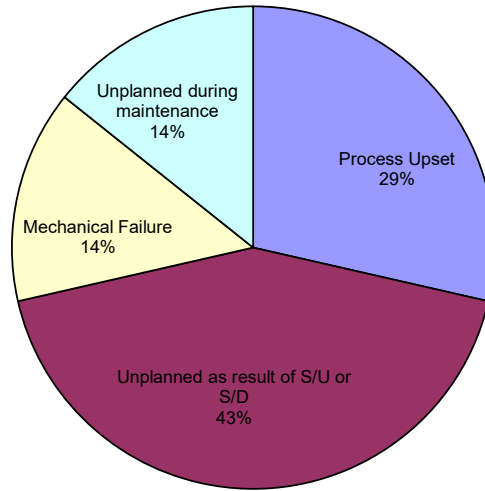

Flaring Prior to November 2006

Because vent gas in the OPCEN Hydrocarbon flare had not been recoverable prior to November 2006, even minor maintenance and depressuring caused measurable flaring. In consequence, statistics on flow rates and durations for operations and maintenance related flare activity prior to November 2006 don't merit further review here. This is because they were not constrained by the ability to manage flows within the capacity of recovery compressors.

The relevant measure is flared volumes. During the development of the flare gas recovery project, normal flows in the vent headers of the two flare systems were closely evaluated. This analysis indicates that the normal traffic in the OPCEN flare header is less than 0.2 million standard cubic feet per day (MMSCFD), with the header purges currently used to prevent air intrusion into the system removed¹⁷. In comparison, background traffic moved by the Delayed Coking Area flare gas recovery compressors is about 2 MMSCFD.

With historical performance profoundly biased by absence of flare gas recovery, this review concentrated on calendar year 2005. Flare data are depicted in Figure 13. Total emissions of non-methane hydrocarbon during 2005 were approximately 30 tons. Emissions of SO₂ in 2005 were 0.3 tons.

¹⁷ Purge gas (typically nitrogen) is provided to all flares to prevent oxygen intrusion from the flare stack into the flare header. Without this purge, oxygen can combine with hydrocarbon gas and cause combustion or detonation within the flare header. Where a water seal is present, the location of the purge is moved downstream of the water seal. However, the industry standard practice is to provide purge flows whether or not the seal is present (this will be discussed further in the section on the Flexigas flare). After the flare gas recovery project started up, the purge upstream of the water seal could be eliminated to not contribute a load on Delayed Coker flare gas recovery compressors. The relocated purge gas (nitrogen in this case) downstream of the water seal will not result in emissions of non-methane hydrocarbon or sulfur dioxide.

**Figure 13. OPCEN Hydrocarbon Flare Gas Volumes
(2005)**

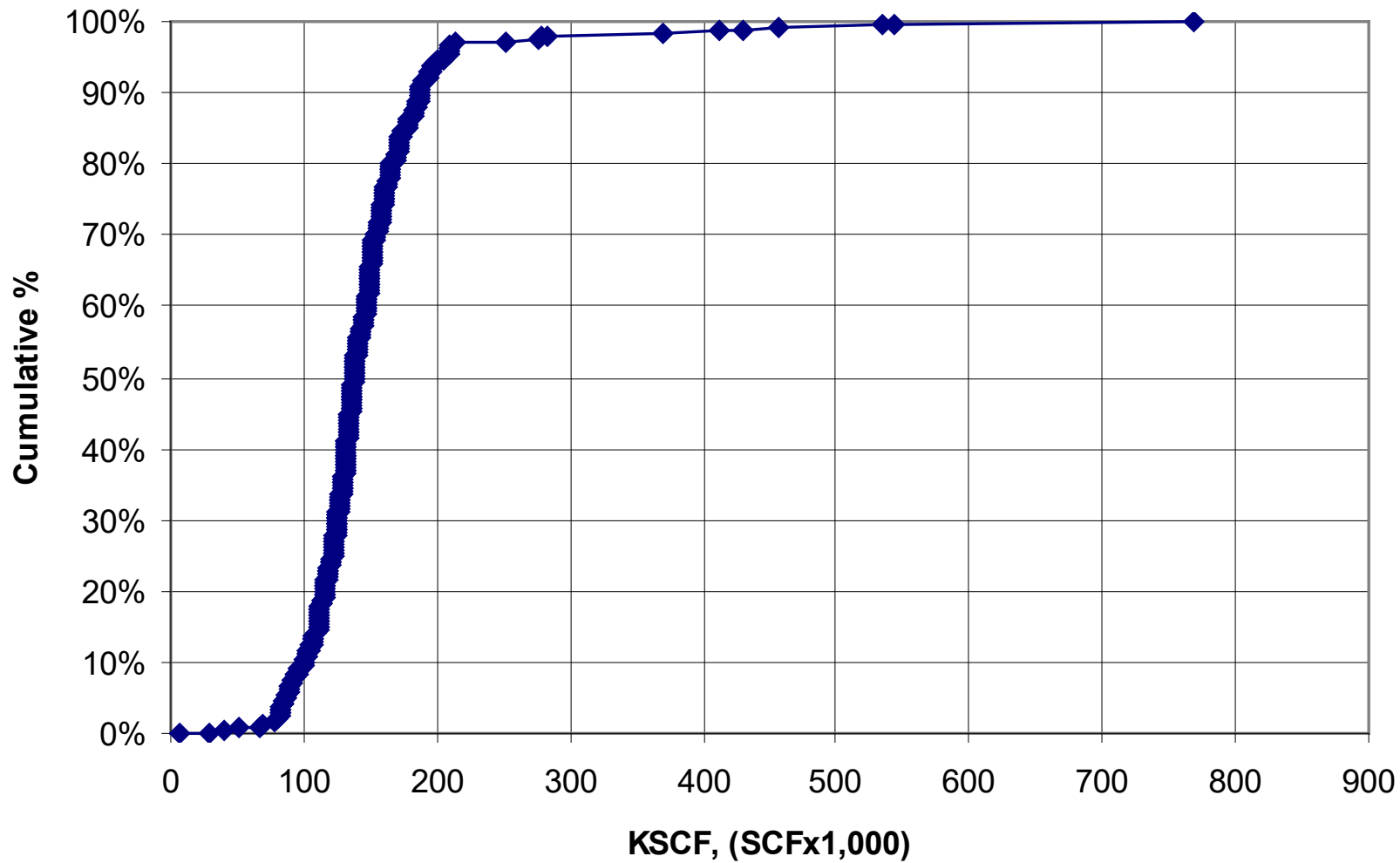

III. REDUCTIONS PREVIOUSLY REALIZED (12-12-401.2)

Equipment, processes and procedures installed or implemented to reduce flaring are listed below.

HARDWARE AND PROCESS REVISIONS

- A. A project was installed in January 2006 to improve cooling for the Dimersol Unit reactor effluent. This revision is expected to allow the unit to more reliably meet expected run lengths between maintenance turnarounds. Before this change, fouling of the reactor effluent air cooler required a unit shut down once a year to clean the exchangers. During the shutdown it was necessary to temporarily flare unit feed, and de-inventory the unit to the flare. Since the Dimersol Unit converts propylene to gasoline components, propylene, in excess of that allowed in product, was put into the fuel system. This periodically contributed to flaring treated Flexigas during the maintenance turnaround because of a fuel gas imbalance.
- B. Modifications were made to the Wet Gas Compressor (WGC) to allow for full recycle on FXU start-up and shutdown in September 2003. This change helps to keep the WGC out of surge and reduce the potential for flaring during Flexicoker Unit start-up and shutdown.
- C. The potential for flaring from all sulfur plant regenerators (DEA Strippers and the Flexorb stripper) has been virtually eliminated by providing automated reboiler steam cuts when pressures in the column approach relief. This steam cut prevents an overpressure of the system, which would result in venting to the flare through pressure relief valves on the Overhead Accumulator.
- D. The OPCEN Hydrocarbon flare was provided with a water seal pot and process interconnection to allow use of the Delayed Coking area flare gas recovery compressors for recovery of vent gases that would normally be flared. The project was operational in November 2006. Project cost was approximately \$2,700,000. Based on actual 2005 emissions of non-methane hydrocarbon (30 tons) the cost effectiveness of this project is approximately \$12,800/ton.
- E. Instrumentation changes were made in September 2006 to increase the range of the Flexicoker Unit Wet Gas Compressor interstage liquid knock-out pot flow control valve to reduce the potential for flaring due to a trip of the compressor on high liquid level.
- F. A lock was installed in February 2007 to prevent inadvertent bumping of the local/remote control switch on the FXU wet gas compressor.

PROCEDURAL REVISIONS

The OPCEN Hydrocarbon flare was provided with Flare Gas Recovery in November 2006. Prior to this date, it had been impossible to safely prevent flaring during shutdowns and planned major maintenance or turnarounds since there was no vapor recovery. However, the refinery practice to minimize environmental impacts of planned shutdowns and major maintenance work has been in place for several years. Two activities are provided below.

- A. Procedural modifications were made for loading the polysulfide vessel at the FXU (March 2004). The modifications were made to improve pressure control on the vessel, thereby minimizing the potential of flaring due to venting from the vessel. The procedure involved stopping the flow of nitrogen purge gas to the vessel (which is vented to the flare) when the vessel was being re-filled. This eliminated the contribution of the nitrogen purge to the flare header which prior to the flare vapor recovery project, would have been directly flared. With

the start-up of the OPCEN flare recovery project, the procedure to stop the nitrogen purge during vessel refilling is no longer necessary since the nitrogen purge is recovered by the flare compressors and no longer goes directly to the flare.

- B. Each turnaround and major maintenance block, and the related shutdown and startups are required to develop specific plans to minimize environmental impacts. The Operating Department and Turnaround groups develop plans with input from the Planning Group and Environmental Affairs. Status and expected impacts are shared across the refinery during the turnaround. The overall environmental performance is reviewed after the turnaround to develop “lessons learned” for subsequent turnarounds.

IV. PLANNED REDUCTIONS (12-12-401.3)

HARDWARE AND PROCESS REVISIONS

In light of the flaring review since implementation of the recovery project, no further hardware or process revisions are planned on the OPCEN HC flare at this time. The FMP will continue to be updated at least annually with any revisions developed from the causal analyses of future flaring events.

PROCEDURAL REVISIONS

The four procedures described separately are applicable to this flare. These procedures were implemented November 1, 2006.

V. PREVENTION MEASURES (12-12-401.4)

401.4.1 Prevention Measures for flaring due to planned Major Maintenance

Based on the historical review of flaring incidents, the OPCEN flare gas recovery project provides sufficient capacity to allow Turnaround and Major Maintenance activities to be conducted without planned flaring. However, similar to the discussion concerning the other process flares, flaring can occur due to unexpected events. The flaring will follow procedure C(F)20 and/or C(F)21 to ensure that flaring is minimized as much as possible and lessons learned are captured for the future. As long as MRC follows these procedures, any flaring that occurs, whether predicted or unexpected, will be minimized as much as possible and the flaring reviewed to determine if there are prevention measures that can be implemented to further reduce flaring. When these procedures are followed, any flaring is consistent with the FMP.

Until the OPCEN HC recovery project was started up, flaring continued when process units either relieved or had to be depressured to the flare. The project was implemented as rapidly as hardware could be acquired, necessary process connections provided, and operating personnel trained. The project was operational in November 2006.

401.4.2 – Prevention Measures for flaring due to issues of gas quantity and quality including review of existing vent gas recovery capacity

Flaring due to gas quantity: In the absence of flare gas recovery, issues of gas quantity and quality were not a factor. All gases entering the flare header were flared. This regular flare gas flow was eliminated by the flare vapor recovery project. Comparing the average flaring rate prior to recovery to the flaring rate after recovery, over 99.5% of the gas that was previously flared is now being recovered.

Flaring due to gas quality: Performance of the Delayed Coking Area recovery system with respect to gas quality has been presented earlier. There are no unusual properties of the flare header gas in OPCEN that would affect the historical performance of the system.

Existing Vent Gas Recovery Capacity: With the recovery project complete, the vent gas recovery capacity and alternatives to increase recovery efficiency beyond the expected 99.5% are the same as those presented for the Delayed Coking Area flare and are presented in that section.

401.4.3 Recurrent Failures

There have been no recurrent failures in equipment routed to the OPCEN Hydrocarbon flare in the period since July 2005.

D. FLARE SYSTEM: OPCEN FLEXIGAS FLARE

BAAQMD Source No. 1771

I. SYSTEM DESCRIPTION (12-12-401.1)

The OPCEN Flexigas flare is a dedicated flare serving the Flexicoker Reactor/Heater/Gasifier. The Flexigas flare only combusts flexigas (FXG). This flare differs significantly from all other process flares serving Bay Area refineries for reasons described below. A simplified process sketch is provided in Figure 14. Details of the system are provided in Appendix D.

Low BTU fuel gas: Flexigas (FXG) is a low-BTU fuel gas produced by gasifying coke produced in a fluid-bed Coker. Due to the air used in the gasifying process, Flexigas is approximately half nitrogen. The bulk of the remaining components are hydrogen and carbon monoxide. The gas is produced and supplied at a relatively low pressure compared with the refinery fuel gas system. Compressors are not used because the volume of gas (210 MMSCFD) would result in tremendous and unnecessary cost.

All Flexigas is treated for sulfur removal: All of the Flexigas produced from the Flexicoker Reactor/Heater/Gasifier is cooled and routed to the Flexsorb Unit. Flexsorb removes H₂S down to a level typically lower than that of refinery fuel gas¹⁸. Control valves on Flexsorb column overhead piping provide the stable backpressure necessary to assure reliable operation of the Flexicoker. A separate control valve maintains the required minimum purge flow through the Flexigas flare header to prevent air intrusion into the header.

High recovery of Flexigas: There are approximately 19 heaters in the refinery that can use Flexigas as a fuel. Combusting Flexigas results in lower NO_x emissions than combustion of either refinery fuel gas or natural gas and its use is an integral part of the refinery's NO_x emission reduction program. The specific number and capacities of the individual heaters varies depending upon process unit turnarounds and refinery operation. The vast majority of the time there are more consumers than required to consume all Flexigas. This is why the Flexigas system has the highest effective "recovery" of all potentially flared gases. Of all Flexigas produced during 2005, only 0.08% ended up in the flare as the result of dynamic movement in the refinery fuel system.

All Flexigas emissions in permit cap: When a Flexigas user unexpectedly comes off-line, it can be difficult to rapidly take up the available gas. Because of the high flows involved, a volume of gas exceeding the Air District definition of flare "event" (0.5 MMSCF) may result before the Flexicoker can reduce production of this gas. In this case, treated Flexigas may be temporarily flared. Emissions from burning flexigas, whether in refinery heaters or the flare, are subject to the permit limits in our refinery emission cap.

¹⁸ Because of its low emissions of SO_x, NO_x and particulates, Flexigas is the fuel flared during those brief periods where a fuel system imbalance occurs as a result of process upset. This may increase the flaring at the Flexigas flare, but results in lower emissions than flaring any other fuel.

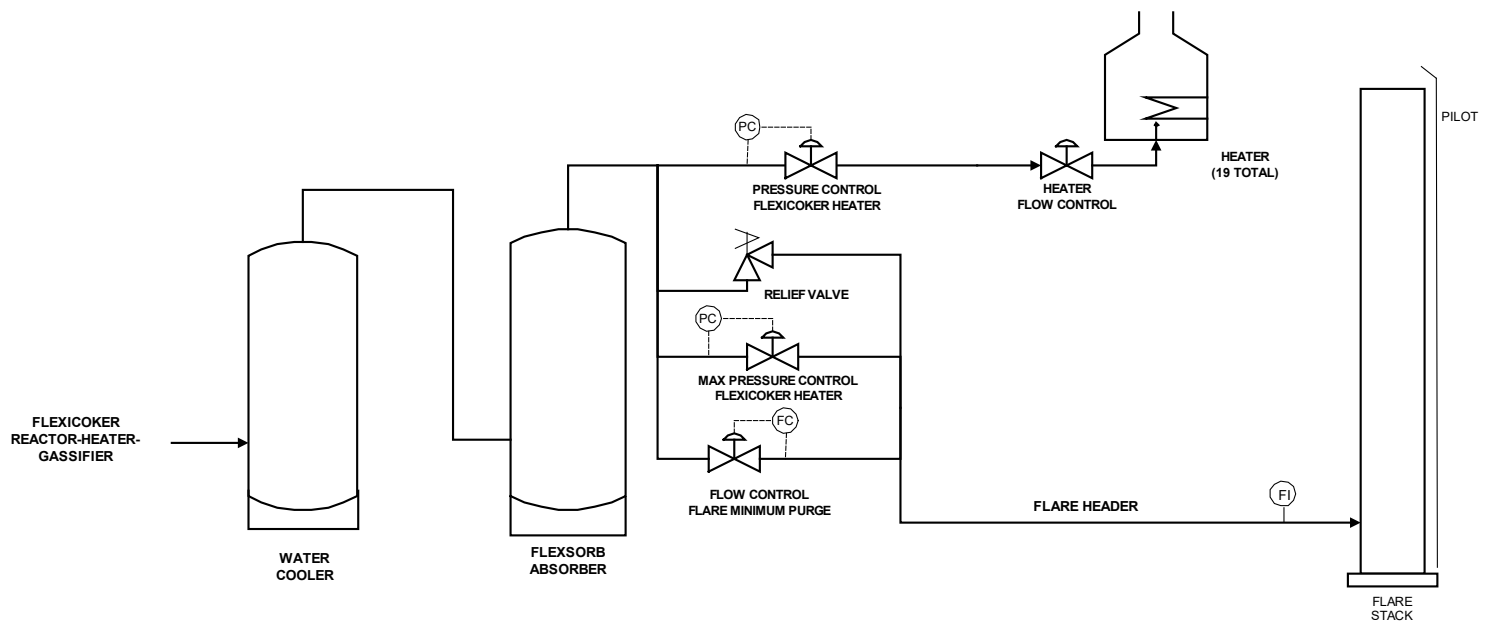

FIGURE 14. FLEXIGAS SUPPLY SYSTEM PROCESS SKETCH

II. HISTORICAL FLARING REVIEW

Summary:

Flexigas (FXG) flare activity 7/1/20 – 6/30/21

There were no flaring events requiring Causal Analysis at the FXG flare during this 12-month period. Small FXG flaring events can occur due to sudden pressure changes in the Flexigas system as a result of refinery heater issues causing short term fuel gas imbalance. All of the flexigas flared was treated for sulfur removal and met fuel gas specifications.

Flexigas (FXG) flare activity 7/1/19 – 6/30/20

There were three flaring events requiring Causal Analysis at the FXG flare during this 12-month period. The first event occurred on October 8, 2019 during the restart of the Flexicoker. To avoid upset of the refinery heaters as the composition of the Flexigas changes and to avoid poisoning the Flexisorb solution in the early stages of gasification, it is necessary to flare Flexigas during Flexicoker startup and shutdown. This flaring is specifically allowed by MRC's Title V permit and emissions are included under MRC's emission caps.

The second event occurred on October 15, 2019. The Flexicoker lost coke circulation due to improper coke size distribution plugging the coke outlet of the reactor, causing coke levels in the reactor to rise. This resulted in an upset of the Flexicoker unit where FXG had to be sent to the flare. As a preventative measure, during unscheduled shutdowns where coke is unloaded from the unit to the storage silo, coke sampling will be considered if new coke from an alternate source is needed prior to restart.

The last flaring event happened on October 25, 2019. The Flexicoker was experience coke flow circulation problems resulting in excess production of FXG that had to be flared. In response, the feed was cut back and steps were taken to restore coke circulation to normal levels. As a preventative measure, a valve was modified to reduce likelihood of coke flow circulation issues.

Small FXG flaring events can occur due to sudden pressure changes in the Flexigas system as a result of refinery heater issues causing short term fuel gas imbalance. Small flexigas flaring events also occur due to coke imbalance issues. All of the flexigas flared during these small events were treated for sulfur removal and met fuel gas specifications.

Flexigas (FXG) flare activity 7/1/18 – 6/30/19

There was one flaring event requiring a Causal Analysis for the FXG flare during this 12-month period. The flaring event occurred at the FXG flare on June 12, 2019 during a loss of condensate. The condensate supports the operation of several pumps that are necessary to provide cooling for the Flexicoker. To prevent equipment from exceeding maximum allowable temperatures, equipment was bypassed and flexigas was routed from the heaters to the FXG flare. The loss of condensate was, in part, a result of check valves failing, causing light hydrocarbons to contaminate the condensate system. As a result of the investigation, additional check valves will be installed to minimize the opportunity for contamination of the condensate system.

Small FXG flaring events can occur due to sudden pressure changes in the Flexigas system as a result of refinery heater issues causing short term fuel gas imbalance. All of the flexigas flared was

treated for sulfur removal and met fuel gas specifications. Our process control engineers continue to fine tune the Flexigas pressure control scheme to reduce Flexigas flaring.

Flexigas (FXG) flare activity 7/1/17 – 6/30/18

There were one flaring event requiring Causal Analysis on the FXG flare during this 12-month period. The reportable flaring event occurred during an emergency feed diversion in the Flexicoker Unit on August 16. The feed was diverted due to a leak in the gas plant on the debutanizer column. The leak was caused by a failure of the chemical injection tubing. Proposed prevention measures included evaluating the need and design of the injection tubing.

Small FXG flaring events can occur due to sudden pressure changes in the Flexigas system as a result of refinery heater issues causing short term fuel gas imbalance. All of the flexigas flared was treated for sulfur removal and met fuel gas specifications. MRC's process control engineers continue to fine tune the Flexigas pressure control scheme using the COGENs to absorb these pressure swings and reduce Flexigas flaring.

Flexigas flare activity 7/1/16 – 6/30/17

There were no reportable flaring events requiring causal analysis on the Flexigas (FXG) flare during this reporting period. Flexigas flaring did occur as a result of the partial refinery power outage in December 2016. The FXG flaring was included with the causal analysis report that was done for the LOP flaring during the power outage.

Small FXG flaring events can occur due to sudden pressure changes in the Flexigas system as a result of refinery heater issues causing short term fuel gas imbalance. Small flexigas flaring events also occur due to coke imbalance issues. Most of the improvements to minimize flexigas flared is due to the fine tuning of the Flexigas pressure control scheme using the COGENs to absorb these pressure swings. All of the flexigas flared was treated for sulfur removal and met fuel gas specifications.

Flexigas flare activity 7/1/15 – 6/30/16

The increase in Flexigas flare flow described in the Executive Summary was largely the result of six reportable flaring events requiring causal analysis on the Flexigas (FXG) flare during this reporting period. Four of the six flaring events occurred during shutdowns and startups of the unit (1 planned and 1 due to an emergency).

The first and second reportable flaring events occurred during an emergency feed diversion in the Flexicoker Unit on 1/12/16 and subsequent feed re-introduction on 1/23/16. The feed was abruptly diverted when a hot spot was seen during routine thermal inspection of process lines. Flexigas had to be removed from the refinery heaters and sent to the flare while the unit was being shut down. The flared flexigas was treated for sulfur removal and met fuel gas specifications during the event. The hot spot in the line was caused by internal refractory damage.

The third and fourth reportable flexigas flaring events during this reporting period occurred in February 2016 and were the result of "stalling" in the Flexicoker's gasifier feed line. The cause of the stalling is plugging in the line typically due to coke or scale build-up. The emergency shutdown in January may have contributed to the line plugging resulting in the stalling events.

The fifth and sixth FXG reportable flaring events occurred during shut down and startup of the Flexicoker for a planned turnaround that began in May 2016. As discussed in Section 5 – Prevention

Measures for flaring due to planned major maintenance and issues of gas quality, it is necessary to flare Flexigas during Flexicoker startup and shutdown to avoid upset of the refinery heaters as the composition of the Flexigas changes and to avoid poisoning the Flexorb solution in the early stages of gasification. This flaring is specifically allowed by MRC's Title V permit and emissions are included under MRC's emission caps.

Small FXG flaring events can occur due to sudden pressure changes in the Flexigas system as a result of refinery heater issues causing short term fuel gas imbalance. All of the flexigas flared was treated for sulfur removal and met fuel gas specifications. Our process control engineers continue to fine tune the Flexigas pressure control scheme using the COGENs to absorb these pressure swings and reduce Flexigas flaring.

Flexigas flare activity 7/1/14 – 6/30/15

There were no reportable flaring events requiring causal analysis on the Flexigas (FXG) flare during this reporting period.

Small FXG flaring events can occur due to sudden pressure changes in the Flexigas system as a result of refinery heater issues causing short term fuel gas imbalance. Small flexigas flaring events also occur due to coke imbalance issues. As shown in Figure ES-2 in the Executive Summary the amount of flexigas flared during 2014 and 2015 year to date is the lowest recorded since 2004. Much of this improvement is due to the fine tuning of the Flexigas pressure control scheme using the COGENs to absorb these pressure swings. All of the flexigas flared was treated for sulfur removal and met fuel gas specifications.

Flexigas flare activity 7/1/13 – 6/30/14

There was one reportable flaring event requiring causal analysis on the Flexigas (FXG) flare during this reporting period. The flaring occurred during a feed diversion on 7/24/13 and subsequent feed re-introduction on 7/28/13 in the Flexicoker Unit. The feed was abruptly diverted due to the failure of the pump shaft seal on one of the Flexicoker Reactor Feed Pumps. Flexigas had to be removed from the refinery heaters during the diversion while the unit was stabilized. The flexigas was treated for sulfur removal and met fuel gas specifications during the event. The pump shaft seal failure was caused by coke debris lodged in the impeller resulting in impeller imbalance and failure of the pump bearings. It is believed that the coke formed in the pump suction line downstream of the strainers. Although the pump suction lines are flushed during each turnaround, it may have been difficult to see coke in the line. To prevent this event from recurring, the maintenance template for the reactor feed pumps was modified to specifically include cleaning of the suction lines any time the pump is removed from service in addition to during each turnaround.

Small FXG flaring events can occur due to sudden pressure changes in the Flexigas system as a result of refinery heater issues causing short term fuel gas imbalance. Only five small events occurred during the last period compared to 17 in the previous period. Much of this improvement is due to the fine tuning of the Flexigas pressure control scheme using the COGENs to absorb these pressure swings and reduce Flexigas flaring.

Flexigas flare activity 7/1/12 – 6/30/13

There were four reportable flaring events requiring causal analysis on the Flexigas (FXG) flare during this reporting period. One of these events occurred during a flaring event on the LOP flare when the HCU 1st stage shut down due to a lube oil fire. The Flexigas flare flow and emissions were

included in the Causal Analysis Report for this event and are discussed in the LOP section of this FMP.

The second Flexigas flaring event triggering Causal Analysis occurred on August 14, 2012 when the Flexicoker Debutanizer column pressure relief valve failed and feed had to be removed from the FXU to stop generation of feed to the column. There was also flaring on the OPCEN HC flare during this event when the column was depressured and this flaring was included in the Causal Report.

The third and fourth FXG flaring events that were greater than 500 MSCF occurred during shut down and startup of the Flexicoker for a planned turnaround that began in August 2012. Flaring occurred when the FXU was shut down on 8/28/12 and again when it was started up on October 26, 2012. As discussed in Section 5 – Prevention Measures for flaring due to planned major maintenance and issue of gas quality, it is necessary to flare Flexigas during Flexicoker startup and shutdown to avoid upset of the refinery heaters as the composition of the Flexigas changes and to avoid poisoning the Flexorb solution in the early stages of gasification. This flaring is specifically allowed by MRC's Title V permit.

Small FXG flaring events can occur due to sudden pressure changes in the Flexigas system as a result of refinery heater issues causing short term fuel gas imbalance. Our process control engineers continue to fine tune the Flexigas pressure control scheme using the COGENs to absorb these pressure swings and reduce Flexigas flaring. In April 2013, a heater tripped putting excess Flexigas into an already tight fuel gas system. Operations reported that the improvements on the Flexigas pressure control scheme “worked perfectly and caught the FXG header before it hit the flare.” In the past with a system this tight, flaring would have taken place.

Flexigas flare activity 7/1/11 – 6/30/12

There were two reportable flaring events requiring causal analysis on the Flexigas (FXG) flare during this reporting period. The first event occurred in July 2011 when the Flexicoker Unit lost both feed pumps due to an electrical short circuit that occurred during electrical maintenance in a substation. Electricians were testing the coil resistance between two contactors and they closed the breaker on the wrong contactor which caused the short circuit and shutdown of the pumps. The labeling on the contactors was not clear and the wording was confusing. Several prevention measures were implemented as a result of this event to help prevent a similar electrical issue in the future.

The second reportable flaring event occurred in May 2012 when the Flexicoker Air Blower shut down on low lube oil pressure following preventative maintenance on the lube oil pump when Operations was putting the pump back in service. The lube oil pressure swung and a pressure regulator on the discharge line from both lube oil pumps to the lube oil reservoir failed in the open position. The shutdown of the Air Blower resulted in a significant process upset on the Flexicoker Unit. Prevention measures were implemented as a result of this event.

Flexigas flare activity 7/1/10 – 6/30/11

There were three reportable flaring events requiring causal analysis on the flexigas (FXG) flare during this reporting period. These events were all unplanned due to process upset or malfunction of equipment.

Two of the flaring events occurred when heaters which are major consumers of flexigas experienced emergency shut downs resulting in a fuel gas imbalance in the flexigas system. During both of these events, the COGENs increased flexigas consumption as much as possible. This reduced the amount of flexigas flared and the length of time each flaring event lasted.

The third reportable flaring event occurred when a refrigeration chiller was shut down for maintenance. The shutdown unexpectedly resulted in a large increase in refinery fuel gas production which threatened to overpressure the fuel gas blend drum. Since all flexigas produced is treated in the Flexorb Unit for sulfur removal, the refinery preferentially flared the treated flexigas rather than the untreated refinery fuel gas until the fuel gas system could be brought back into balance. Flaring flexigas over other flare gas significantly reduced the amount of SO₂ produced from the flaring.

Prevention measures were implemented as a result of all of these events to minimize and possibly eliminate flaring due to these causes in the future. The prevention measure that was implemented in 2010 to allow flexigas combustion in the COGENs has been very successful in minimizing the amount of flexigas flared. Approximately 10-15 MMSCFD of flexigas that might otherwise be flared typically can be combusted in the COGENs.

Flexigas flare activity 7/1/09 – 6/30/10

There were six reportable flaring events requiring causal analysis on the FXG flare during this 12-month period. Four of the reportable events occurred 2009 and two in 2010 (through 6/30/10). Two of the flaring events in 2009 were associated with the shutdown and startup of the Flexicoker Unit (FXU) for a scheduled turnaround. As discussed in Section 5 – Prevention Measures for flaring due to planned major maintenance and issue of gas quality, it is necessary to flare Flexigas during Flexicoker startup and shutdown to avoid poisoning the Flexorb solution in the early stages of gasification. This flaring is specifically allowed by MRC's Title V permit.

The other FXG flaring events were unplanned due to process upset or malfunction of equipment. All of the FXG flared during these unplanned events, was treated for sulfur removal and emissions from the combustion of FXG whether in the refinery heaters or the flare is included in our refinery emission caps. Each of the flare events was investigated and prevention measures identified and implemented (see Part 3 of this Section – Reductions Previously Realized). The results from the investigations into these events were reported to the District in Causal Analysis reports. All flaring, when it occurred, was minimized and stopped as quickly as possible.

Flaring of treated flexigas can occur due to fuel gas imbalance when a flexigas consumer experiences a process upset or trips offline resulting in reduced refinery flexigas consumption. The Flexicoker cannot be slowed down fast enough in these circumstances to avoid flaring without risk of additional upset. Beginning in January 2010, the refinery implemented a project to allow the combustion of flexigas in MRC's COGEN unit to provide an additional flexigas consumer which can quickly change consumption without process or utility steam impacts. The amount of flexigas flared during a flaring event on January 11, 2010 was less than what would have been flared prior to this project, although it still exceeded the Causal Analysis trigger. In contrast, a flexigas flaring event occurred in April 2010 when a control valve failed closed due to a sheared locking pin resulting in the trip of a large flexigas consuming heater. The excess flexigas was combusted in COGEN allowing time for the Flexicoker to slow down. For this event, the flexigas to COGEN project resulted in a significant reduction in the amount of flexigas that would have otherwise been flared. As described in Section 4 - Planned Reductions, a prevention measure is being evaluated that may allow additional flexigas combustion in COGEN.

Flexigas flare activity 6/1/08 – 6/30/09

There were two reportable flaring events requiring causal analysis on the FXG flare during this 13-month period. The two reportable flaring events occurred in January 2009 and March 2009. Both were unplanned events due to process upset or malfunction of equipment. These flare events were investigated and prevention measures identified and implemented (see Part 3 of this Section – Reductions Previously Realized). The results from the investigations into these events were reported to the District in Causal Analysis reports. None of the flaring that occurred was planned. All flaring, when it occurred, was minimized and stopped as quickly as possible.

Flexigas Flare Activity 1/1/06 – 6/1/08

Flexigas flare activity since 1/1/06 was reviewed for potential reduction opportunities. Figure 2008-5 shows the FXG flare flows over this time period. There were 11 events that required Causal Analysis. All of these flaring events were investigated and prevention measures identified and implemented (see Part 3 of this Section – Reductions Previously Realized). The results of the investigations into these events were reported to the District in Causal Analysis reports.

There were three large Flexigas flaring events over the time period reviewed. Flaring occurred in July and again in August of 2006 as a result of the shutdown and subsequent startup of the Flexicoker for planned major turnaround. This flaring is described below in the Prevention Measures Section under “Flaring due to planned major maintenance and issues of gas quality.” As discussed in this section, it is necessary to flare Flexigas during Flexicoker startup and shutdown to avoid poisoning the Flexorb solution in the early stage of gasification. Flexigas flaring in March 2007 occurred as a result of an emergency trip of the Flexicoker. As described in the Causal Analysis report for this event, it was necessary to flare treated flexigas until the unit could be re-started.

The other flexigas flaring events that triggered Causal Analyses were smaller events. Most of these flexigas flaring events occurred as a result of fuel gas imbalance. Because there is currently not a flexigas consumer which can quickly change consumption without process or utility steam impacts, any excess flexigas is flared until the Flexicoker can be slowed down enough to reduce flexigas production. A flexigas consumer that could be quickly ramped up or down could reduce some of the flexigas that currently would have to be flared.

FIGURE 2008-5

FXG Flare Flows 1/1/06 - 6/1/08

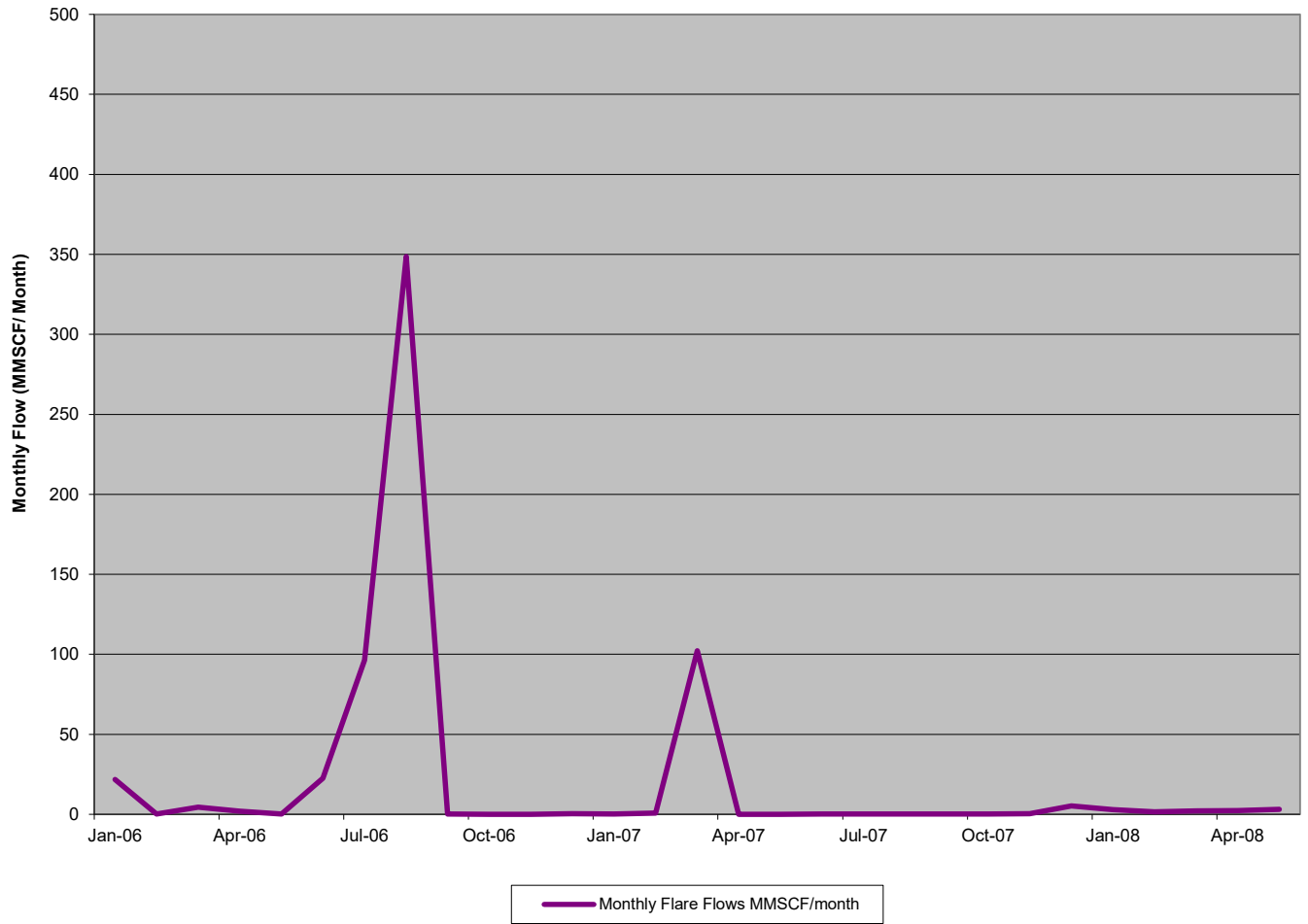

Historical Flaring Review

Historical flaring at the OPCEN Flexigas flare was reviewed to identify opportunities for potential mitigation. The highest quality data are available for the period from December 2003, to January 2006. This coincides with installation of the flare flow meter and BAAQMD flare reporting. Data for 2005 are plotted in Figure 15 and Figure 16.

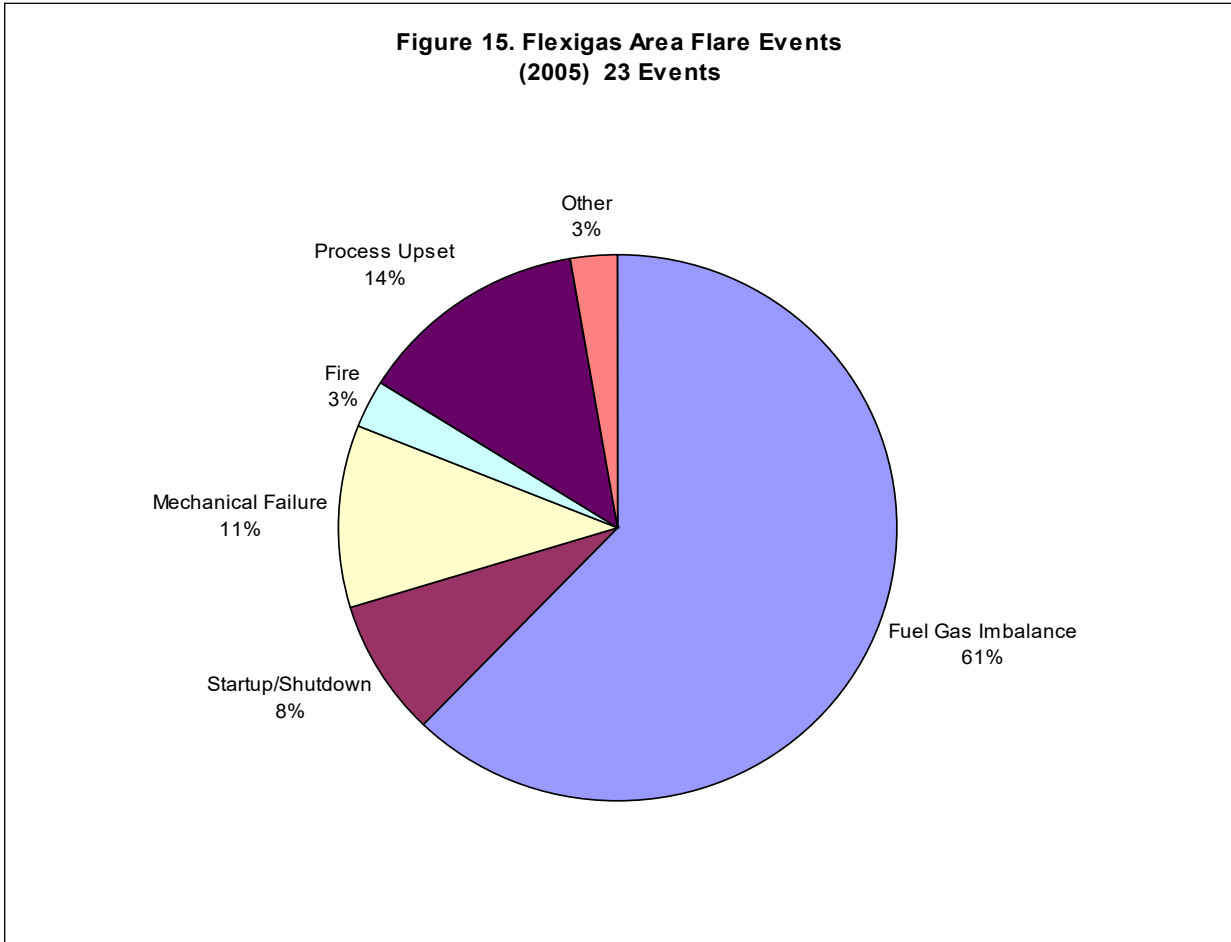

**Figure 16. Flexigas Flare Gas Volumes
(2005)**

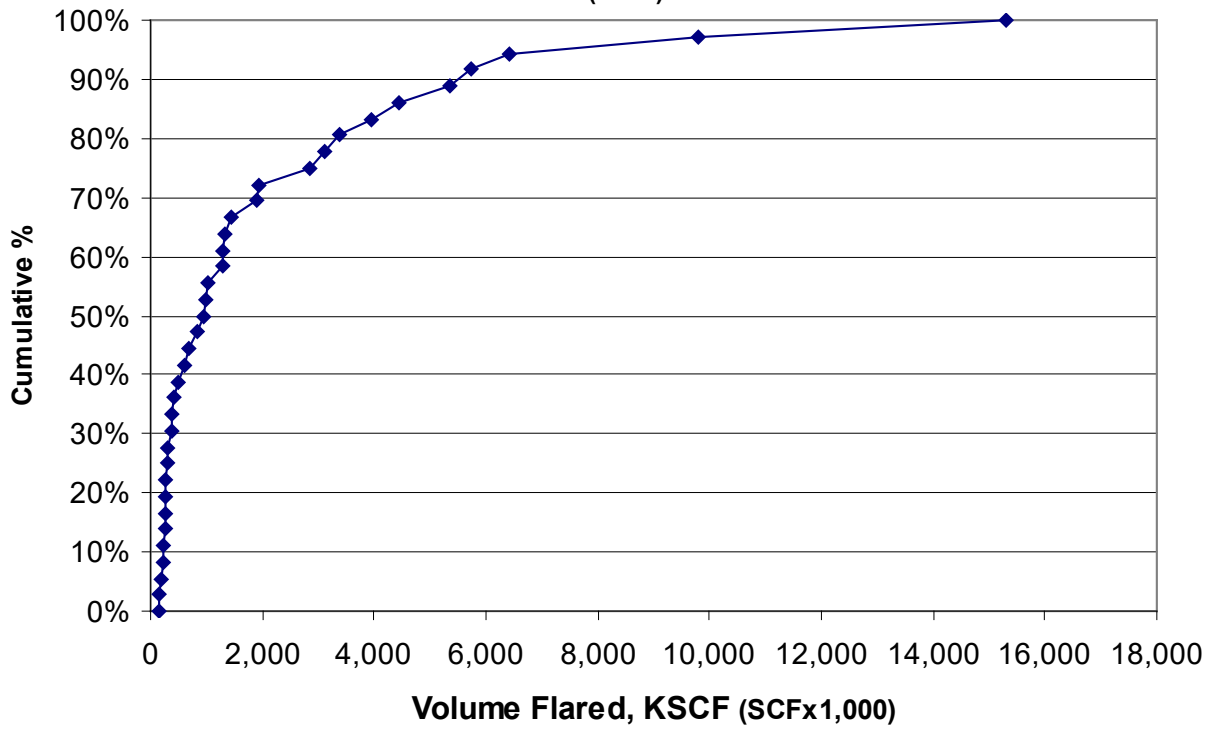

III. REDUCTIONS PREVIOUSLY REALIZED (12-12-401.2)

Equipment, processes and procedures installed or implemented with the last five years to reduce flaring include;

HARDWARE AND PROCESS REVISIONS

(A) The Stretford Unit was replaced with a Flexsorb unit in 2005. This project cost approximately \$30,000,000. Sulfur levels in treated flexigas are significantly lower with the Flexsorb process than the earlier Stretford process. The Flexsorb process unit eliminated the problem of sulfur plugging that had occurred with the earlier Stretford process. This plugging had resulted in the need for a dilute caustic wash once or twice each year to remove elemental sulfur from the gas contacting tower. Each caustic wash resulted in the flaring of 6-10 MMSCF of flexigas. Since Flexsorb is not susceptible to plugging, the improved on-stream factor and operating stability result in both significantly less flaring, and lower SO₂ emissions, when flaring does occur.

(B) The control system used to maintain a steady supply pressure of Flexigas to the distribution system has undergone continuous improvement. Revisions implemented during the last FXU turnaround simplified the control system to use standard Honeywell TDC control logic. This control logic is more easily understood by operating personnel. FXU Board operators are generally able to recognize and respond more quickly to upsets. The result is that the new control system has proven more responsive than the previous version which results in less FXG flaring due to upsets in the flexicoker system.

On the Flexigas consumption side, furnace control limits related to FXG were examined and adjusted to allow maximum FXG consumption.

(C) Flexicoker run length (time between shutdowns) has been increased to reduce the volume of untreated Flexigas which must be flared during startup conditions.¹⁹ This change reduces flaring because there are less shutdowns and startups requiring flaring for the same time period of time.

(D) Additional heaters have been converted to Flexigas over the years to increase the number of consumers for this clean burning low-NO_x fuel.

(E) Shutdown of the Catalytic Reforming Unit, a major flexigas consumer, resulted in a Flexigas flaring event in September 2005. The cause of the shutdown was determined to be a leaking flange on a heat exchanger that resulted in a fire. The flange leak was believed to have been caused by thermal cycling of the equipment that occurred during a previous shutdown. Bellville washers were added to the bolting arrangement on the flange to provide more tolerance for thermal expansion. Bellville washers are designed using spring-tension to provide a more constant sealing force on equipment that undergoes temperature cycling. Having a more uniform sealing force is hoped to reduce the potential for an unexpected and rapid unit shutdown due to leaking flanges after reactor regeneration. The type of washer used in this application may change if future evaluation of these washers indicates that a different type of washer is needed to assure reliable and safe unit operation.

(F) In August 2005, Flexigas flaring occurred when the Flexicoker elutriator feed line required inspection and repair due to discovery of a crack near a weld. To help prevent cracking, the elutriator feed line was re-designed. The changes were implemented in July 2006.

¹⁹ Flexsorb is an Exxon/Mobil process. Due to the nature of the Flexsorb solvent, it may be degraded by oxygen that can be present in Flexigas during initial startup. Exxon/Mobil operating guidelines call for this gas to be flared until Flexicoker operation is stable.

- (G) Flexigas flaring occurred in March 2006 due to slowdown of coke transfer in the Flexicoker Gasifier Return Line (GRL) due to refractory spalling in the line. In July 2006, the GRL had a more robust refractory liner installed.
- (H) The Flexicoker heater/reactor/gasifier differential pressure control scheme was simplified and improved in July 2006 to help minimize flaring due to small flexigas imbalances such as what caused FXG flaring in April 2006 and again on July 10 2006.
- (I) FXG flaring occurred in June 2006 when the Catalytic Reformer (CRU) unit shut down suddenly due to low hydrogen circulation flow. The low flow was caused by an entry error in the hydrogen recycle compressor speed controller. The controller's software programming was revised to perform an additional check on any new speed setpoint value added.
- (J) FXG flaring occurred as designed during shutdown of the flexicoker in July 2006 and during the subsequent startup in August 2006. The flaring during both of these times is due to how the Flexicoker is designed. Some amount of flaring is necessary to ensure safe and reliable operation of the process heaters since the composition of the FXG changes during the shutdown and startup periods. If the FXG was sent to the heaters during this time it could cause the heaters to trip off-line resulting in additional flaring. The flaring was minimized by careful review of the startup and shutdown procedures, keeping flexigas in the process heaters as long as possible prior to shutting down the FXU and returning it to the heaters as soon as possible after startup. The amount of flaring during the shutdown in July and the startup of the Flexicoker in August was reduced to approximately 33% of the amount flared during the previous turnaround.
- (K) A flaring event occurred August 31, 2006 due to a high coke level in the FXU heater. A level indication was not working due to a plugged tap. While trying to unplug the tap, the drill bit broke off in the tap and could not be removed. An alternate location for the tap was installed that day to repair the level indication and return the level to normal to prevent additional flaring.
- (L) Flexigas flaring in March 2007 resulted when the Flexicoker tripped offline due to an airflow transmitter failure. The failed transmitter was replaced.
- (M) Flexigas flaring in January 2009 resulted from a Flexigas fuel gas imbalance due to a combination of a major unit turnaround along with operational problems that resulted in reduced flexigas consumption on the heaters in service. A Prevention Measure to provide an additional flexigas consumer by allowing the combustion of flexigas in COGEN was not fully implemented due to technical issues in time for the major unit turnaround. The Prevention Measure should be fully implemented by the end of 2009.
- (N) Flaring in March 2009 resulted from the inability to transfer an adequate amount of coke from the Heater vessel to the Gasifier vessel via the Gasifier Coke Feed Line (GCFL) due to a malfunction of the GCFL slide valve. The slide valve was sent to Houston for a full factory overhaul in August 2009 to ensure that it could move freely and respond to signals from the board operator. The valve and actuator were completely disassembled, inspected and repaired. Repairs consisted of straightening and re-coating of the valve stem, replacement of the flow orifice, replacement of the disc overlay and refractory patching.
- (O) A flaring event in October 2009 occurred due to an excessive flexigas to flare pressure controller bias setting. The process monitoring software was modified to include more coke transfer information to help technical support identify precursors to unstable coke fluidization.
- (P) Flexigas flaring in December 2009 occurred when the Catalytic Reformer Unit tripped offline due to a loss of power resulting in a flexigas fuel imbalance. The Prevention Measure to allow combustion of flexigas in COGEN was not fully implemented at the time of this flaring

event due to technical issues. The Prevention Measure was implemented by the end of December 2009.

- (Q) The loss of power that resulted in the flexigas flaring event in December 2009 occurred when the battery system failed to provide backup power to an instrumentation cabinet. A prevention measure was identified to evaluate battery maintenance practices including optimal replacement cycle and the risk of testing versus replacement. This prevention measure was completed in October 2010.
- (R) A flexigas flaring event occurred in January 2010 due to the unplanned shut down of CO Boiler 2. The shutdown of the CO Boiler along with operational changes required to avoid a major steam system upset resulted in a flexigas fuel gas imbalance. To prevent a similar shutdown from occurring, a low speed alarm on the CO Boiler forced draft fan was set to allow time for the operator to react to low fan speed prior to the unit shutting down. In addition, the setting of the minimum stop for the forced draft fan's controller output signal was increased to help prevent trips when the speed controller is not in manual.
- (S) A flaring event occurred in April 2010 when the air supply to the FXU Gasifier vessel was inadvertently decreased below the trip point of the automatic shutdown system, beginning the shut down process for the FXU. As part of the investigation, the placement of the air supply controller to the Gasifier was reviewed but was not found to be a contributing cause of the event. The output tolerance on the air supply control valve was reduced which will alert the operator in the future if they are making a large move on this valve.
- (T) A flexigas flaring event occurred in January 2011 when the safety shutdown system on one of the hydrogen plants activated on low steam flow to the unit. A project was completed in March to install a minimum stop on the control valve to ensure adequate steam flow to prevent a unit trip.
- (U) The labeling on the front of electrical contactor boxes and breakers in OPCEN was revised to eliminate confusion that resulted in FXG flaring due to a short circuit in 2011. The labeling was revised in September 2011.
- (V) As a result of a flaring event in 2009 a prevention measure was identified to service the Gasifier Coke Feed Line valve to ensure that it can move freely and respond to signals from the board operator to stimulate coke circulation. This work was done in September 2012.
- (W) A FXG flaring event occurred on August 14, 2012 when a pressure relief valve on a debutanizer column in the FXU failed. As a result of this event, all of the pilot operated PRVs that relieve to atmosphere were reviewed. The soft goods kit including the main valve seat was replaced on 3 PRVs in the FXU with a material with increased resistance to H₂S. This work was completed by June 30, 2013.
- (X) A flexigas flaring event occurred on January 12, 2016 during an emergency shutdown of the Flexicoker when a hot spot was observed on the gasifier overhead line during routine thermal inspection of process lines. The line was inspected internally during the FXU turnaround a few months later and repaired back to original specification with new piping segments.
- (Y) A flexigas flaring event occurred on January 23, 2016 during restart of the Flexicoker after an emergency shutdown due to a problem in the gasifier overhead line. The line was inspected internally during the FXU turnaround a few months later and repaired back to original specification with new piping segments.
- (Z) A flexigas flaring event occurred on August 16, 2017 due to a chemical injection tubing failure. Following the incident, the tubing was disconnected and not returned to service. Since it was determined that the debutanizer injection facility was no longer needed, design and review of a new injection facility is not needed at this time. However, if a similar injection

facility is later required, MRC will review facilities and consider the installation of hard-piped double check assembly upstream of the tubing.

- (AA) The flexigas flaring event that started on June 12, 2019 resulted from the failure of check valves. Additional check valves have been installed as preventative measures.

PROCEDURAL REVISIONS

- (A) Due to the volume and composition of Flexigas, it cannot be captured and returned to the refinery fuel system. The balance between production and consumption of this gas must be managed in real time to avoid flaring above the minimum required to prevent oxygen entering the flare stack. Refinery work practices have been significantly affected by the desire to avoid flaring Flexigas. In particular, efforts relating to fuel system management have strict guidelines to minimize Flexigas flaring. These guidelines include direction to reduce Flexigas production and Flexicoker feed rate subject to prevailing requirements for safe and reliable operation of that unit.
- (B) A FXG flaring event greater 0.5 MMSCF occurred in June 2006 during testing of the Instrument Protective Function for the FXU air compressor. The unit was accidentally tripped off line during the test. As a result of this flaring event, procedures were revised to not test the shutdown system during unit operation.
- (C) Plugging in the Flexicoker transfer lines prevented the FXU from quickly re-starting after a trip in March 2007 which resulted in flaring. Procedures were revised to help prevent plugging and minimize flaring in a future similar situation.
- (D) Flaring in March 2009 resulted from the inability to transfer an adequate amount of coke from the Heater vessel to the Gasifier vessel via the Gasifier Coke Feed Line (GCFL) due to a malfunction of the GCFL slide valve. Training was provided to all Flexicoker operators in an effort to better identify and respond to similar events in the future to minimize the amount of flaring.
- (E) Flaring occurred in July 2009 during shutdown of the Flexicoker for a scheduled turnaround and again in September 2009 during subsequent start up. The flaring of Flexigas during these times could not be eliminated but was minimized by careful review by Operations and Process Engineering of the shutdown and startup procedures to minimize the amount of flaring while ensuring the stable operation of the heaters that combust FXG. The FXG was kept in the heaters as long as possible prior to shutting down and was returned to the heaters as soon as possible after startup began. The FXG was treated in the Flexsorb Unit for sulfur removal as long as possible while shutting down to minimize SO₂ emissions. As required by the developer of the Flexsorb process, FXG must be removed from Flexsorb at a certain oxygen concentration to avoid poisoning the Flexsorb solution. MRC's permit to operate limits the SO₂ emissions from flaring of flexigas while Flexsorb is bypassed. The amount of SO₂ emitted during the recent shutdown was less than 2% of the amount allowed by the permit. Learnings from this turnaround will be incorporated into the procedures to assure there is continuous improvement in flare minimization during future FXU turnarounds.
- (F) A flaring event in October 2009 occurred due to an excessive flexigas to flare pressure controller bias setting. Training specific to the bias setting was given to all FXU operators.
- (G) A flaring event occurred in April 2010 when the air supply to the FXU Gasifier vessel was inadvertently decreased below the trip point of the automatic shutdown system. Details of the incident were discussed with all FXU operating personnel to learn from it and avoid a re-occurrence.

- (H) The project to allow combustion of FXG in the COGEN to provide an additional FXG consumer that can quickly change consumption without process impacts was completed in December 2009. A review was completed in July 2010 to determine the maximum ratio of flexigas to fuel gas that can be combusted in COGEN.
- (I) A flaring event unexpectedly occurred in February 2011 during shutdown of a refrigeration chiller for maintenance. The chiller shutdown procedure was revised in April 2011 to minimize the potential for rapid increase in dry gas production impacting the fuel gas system.
- (J) A flexigas flaring event occurred in June 2011 when the Catalytic Reformer Unit tripped due to failure of process instrument tubing. As a result of this flaring event, a detailed review of the refinery procedure for tube fitting assembly and support was conducted. The review was complete and a revised procedure issued in December 2011.
- (K) As a result of the flexigas flaring event in June 2011 that resulted in Catalytic Reformer Unit shutdown, refresher training on the revised refinery procedure for tube fitting assembly and support was conducted for all pipefitters and contractors. The training was completed in January 2012.
- (L) An electrical short circuit and subsequent flaring event occurred in July 2011 during troubleshooting of a chattering floodlight contactor. Additional training and information was presented to refinery electricians on the likely cause of chattering in contactors to simplify troubleshooting. The training was complete by December 2011.
- (M) As a result of the July 2011 flaring event due to the electrical short circuit, an engineering analysis was conducted of electrical breaker coordination to determine if there is a way to ensure an electrical branch breaker would trip prior to the upstream breaker. The analysis was complete in September 2011 and it was determined that there is no way to ensure the branch breaker would trip before the upstream breaker.
- (N) A flexigas flaring event occurred in May 2012 during preventative maintenance of a lube oil pump on the flexicoker air blower. The Lube Oil Pump Switching Procedure was revised in June 2012 to minimize fluctuations in lube oil pressure to prevent a similar event.
- (O) Flaring occurred in August 2012 during shutdown of the Flexicoker for a scheduled turnaround and again in October 2012 during subsequent start up. The flaring of Flexigas during these times could not be eliminated but was minimized by careful review by Operations and Process Engineering of the shutdown and startup procedures to minimize the amount of flaring while ensuring the stable operation of the heaters that combust FXG. The FXG was kept in the heaters as long as possible prior to shutting down and was returned to the heaters as soon as possible after startup began. The FXG was treated in the Flexisorb Unit for sulfur removal as long as possible while shutting down to minimize SO₂ emissions. As required by the developer of the Flexisorb process, FXG must be removed from Flexisorb at a certain oxygen concentration to avoid poisoning the Flexisorb solution. Learnings from this turnaround will be incorporated into the procedures to assure there is continuous improvement in flare minimization during future FXU turnarounds.
- (P) Although not triggered by a Causal Analysis, MRC continues to look for ways to minimize or prevent Flexigas flaring. Fine tuning was done on the Flexigas pressure control system to more smoothly move Flexigas into COGENs when needed due to pressure changes in the Flexigas system. In April 2013, a heater tripped putting excess Flexigas into an already tight fuel gas system. Operations reported that the improvements on the Flexigas pressure control scheme “worked perfectly and caught the FXG header before it hit the flare.” In the past with the system this tight, flaring would have taken place.
- (Q) As a result of a flaring event that occurred on 7/24/13 due to a Flexicoker reactor feed pump seal failure, the maintenance template for the reactor feed pumps was modified to include

cleaning of the reactor feed pump suction lines any time the pumps are removed from service. The template was revised and issued on September 27, 2013.

- (R) Flexigas flaring occurred on February 11, 2016 as a result of stalling in the gasifier feed line due to plugging caused by coke build up in the line. The line was inspected and material causing the plugging was removed during the scheduled turnaround.
- (S) Flexigas flaring occurred on February 16, 2016 as a result of stalling in the gasifier feed line due to plugging caused by coke build up in the line. The line was inspected and the cause of the plugging was removed during the scheduled turnaround.

Flaring occurred in May 2016 during shutdown of the Flexicoker for a scheduled turnaround and again in June 2016 during subsequent start up. The flaring of Flexigas during these times could not be eliminated but was minimized by careful review by Operations and Process Engineering of the shutdown and startup procedures to minimize the amount of flaring while ensuring the stable operation of the heaters that combust FXG. The FXG was kept in the heaters as long as possible prior to shutting down and was returned to the heaters as soon as possible after startup began. The FXG was treated in the Flexsorb Unit for sulfur removal as long as possible while shutting down to minimize SO₂ emissions. As required by the developer of the Flexsorb process, FXG must be removed from Flexsorb at a certain oxygen concentration to avoid poisoning the Flexsorb solution. Learnings from this turnaround will be incorporated into the procedures to assure there is continuous improvement in flare minimization during future FXU turnarounds.

IV. PLANNED REDUCTIONS (12-12-401.3)

HARDWARE, PROCESS and PROCEDURAL REVISIONS

In light of the historical flaring review, the analysis of potential mitigation measures provided below, and the effectiveness of the flare policy and procedures described previously, no further hardware, process or procedural revisions are planned on the Flexigas flare at this time. The FMP will continue to be updated at least annually to include any planned revisions developed from the causal analysis of future flaring events.

V. PREVENTION MEASURES (12-12-401.4)

Two options are presented to improve the efficiency of recovering Flexigas from the current 99.92%. These are presented in section 401.4.2.

401.4.1 Prevention Measures for flaring due to planned Major Maintenance

An important difference between the Flexigas flare and other process area flares is that it does not receive vent gases from maintenance sources such as vessel depressuring. Beyond the very limited windows where Flexigas must be flared during Flexicoker startups and shutdowns to protect the Flexsorb unit, untreated Flexigas is not flared.²⁰ However, turnarounds and major maintenance at other units may remove enough Flexigas consumers from the system that limited Flexigas flaring cannot be prevented. In these cases, flare minimization due to fuel balance procedure C(F)-22 is applicable as well as the minimization of flaring during turnaround and major maintenance in procedure C(A) -1.

²⁰ The Flexsorb Permit to Operate specifies periods where Flexigas may be flared. This permitted flaring is found in MRC's permit condition # 7618. As long as the permit conditions are met, this flaring is consistent with the Flare Minimization Plan.

401.4.2 – Prevention Measures for flaring due to issues of gas quantity and quality including review of existing vent gas recovery capacity

Gas Quantity: All Flexigas that is created is combusted somewhere, either in a process heater or the Flexigas flare. The minimum volume of Flexigas which must be made in order to operate the Flexicoker is approximately 165 MMSCFD. When there are insufficient consumers to handle this volume, the remainder has to be flared. Because of the amount of time required to cut from the normal Flexigas production of approximately 210 MM SCFD, down to the minimum, the volume of Flexigas that can be flared even with best operating practices can exceed the current 500,000 SCF flare event threshold. As a result, two options are considered to reduce or eliminate Flexigas flaring.

OPTION 1: PROVIDE ADDITIONAL FLEXIGAS CONSUMERS (see Figure 17).

The objective of this project would be to provide an additional consumer that can rapidly pick up the Flexigas volumes made available by loss of another consumer (e.g., process heater) for any reason. Because excess Flexigas is available less than 10% of the time (based on the percent of days on which flaring occurred from Figure 16), and the current fuel system is roughly in balance, this consumer must essentially remain in hot standby until needed. This means it must be waiting to burn between 1 MMSCFD and 40 MMSCFD Flexigas when an existing consumer unexpectedly comes off line.

The only remaining consumer at the Martinez refinery not already converted to burn Flexigas that approaches the attributes described above is the Cogeneration Unit Steam Generator. If additional steam is not needed in the refinery, then adding Flexigas to the Cogeneration Steam Generator will produce steam that must subsequently be vented to atmosphere. For the sake of the analysis, MRC assumes the steam produced by Flexigas burned in this boiler can be used in the refinery. In the event that the Cogeneration Steam Generator was only used to burn the Flexigas and the steam had to be vented, the emissions reductions amount to only the difference in combustion efficiencies of process heaters and flares. The project has an estimated cost of approximately \$3,000,000.

Assuming this eliminates all Flexigas flaring, it would reduce emissions of non-methane hydrocarbon by much less than one ton per year²¹. The cost effectiveness of this project using accepted BAAQMD methods is approximately \$19,000,000/ton for non-methane hydrocarbon and \$1,000,000 per ton of Sox. Table 3 summarizes the economic calculations for these and other criteria pollutants. Details of these calculations are provided in Appendix F of this report. If the refinery fuel and steam systems are in balance prior to the flare event, the actual value of produced steam is small. This more realistic assumption results in an even less cost-effective project. In either case, this project is not cost effective for reduction of flaring. However, as described above in the Prevention Measures section, MRC has implemented this project to minimize the impact of slowing the Flexicoker to balance the FXG system.

²¹ Cost-effectiveness based on 2005 reported emissions of NMHC from flaring of flexigas (0.04 tons for the entire year). The average ratio of SO₂ to NMHC emissions over the same period (2005) from the reported monthly flare reports is 20:1 (0.81 tons of SO₂ and 0.04 tons of NMHC emissions were reported). The project described as Option 1 is also not cost-effective based on the reduction of SO₂ emissions (\$950,000/ton of SO₂ reductions).

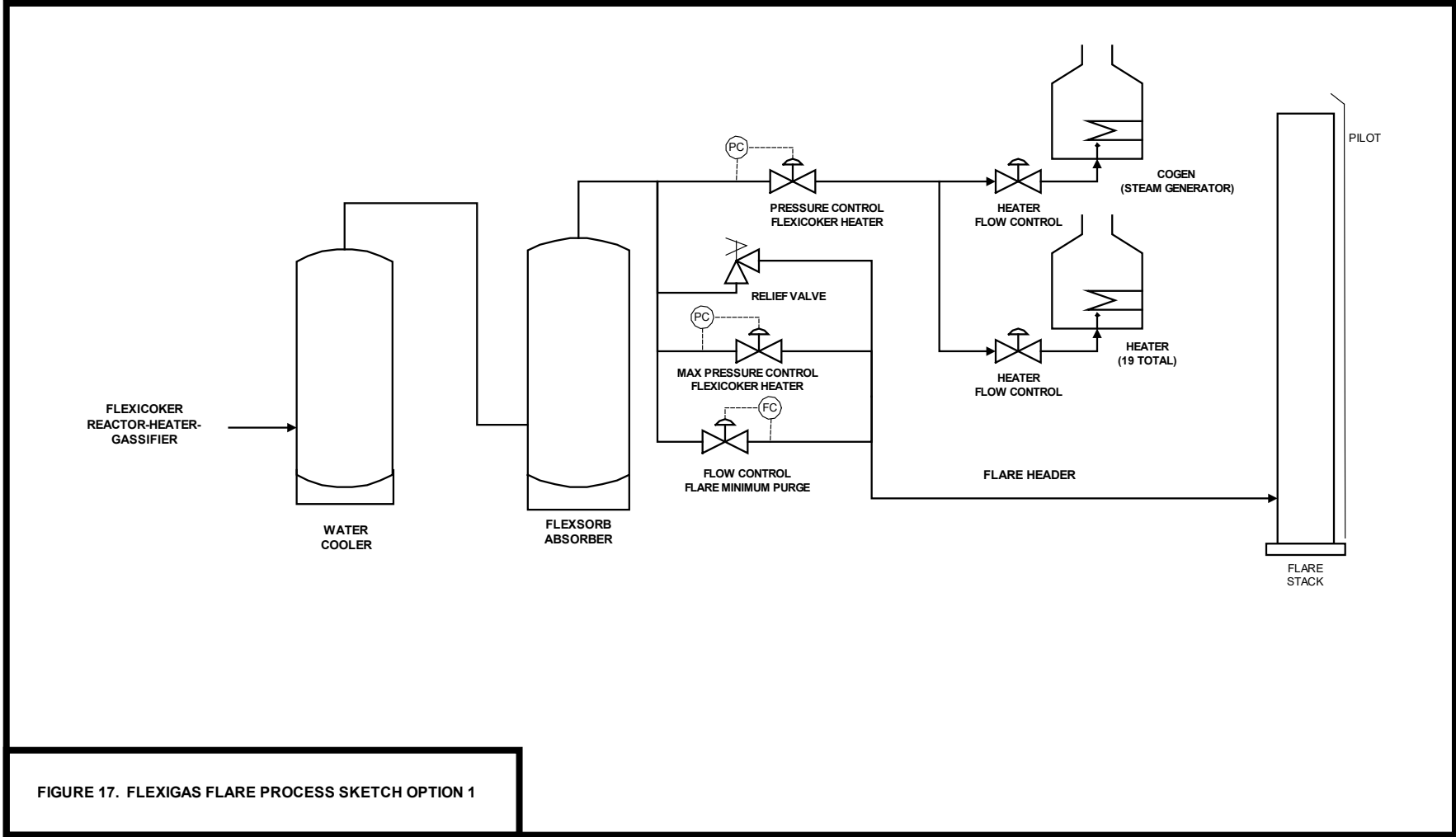

FIGURE 17. FLEXIGAS FLARE PROCESS SKETCH OPTION 1

Table 3. Economic Justification for Addition of Flexigas Consumer

OPTION 1 Route Flexigas to COGEN

Percent Emission Reduction Expected ¹	Capital Cost	Annual Indirect Cost ²	Annual Direct Cost ³	Combined Annual Cost ^{2,3}	Emissions Reductions by Species					Cost Effectiveness of Reductions (\$ Million/ton)				
					(%)	(\$)	(\$/yr)	(\$/yr)	(\$/yr)	NMHC ⁴	SOx ⁵	NOx ⁶	CO ⁶	PM ⁶
100%	\$3,000,000	\$656,000	\$120,000	\$776,000	80	1,620	39	211	6	\$19	\$1.0	\$40	\$7	\$272

¹) Calculations based on Flexigas Flare emissions reported for 2005 assuming 100% reduction

²) Indirect costs include Capital Recovery (10% interest over 10 yr), plus other costs described in the BACT implementation procedure

³) Direct costs include Labor, plus other costs described in the BACT implementation procedure

⁴) Non Methane Hydrocarbon emissions reductions are based on 100% recovery capturing the entire NMHC emissions for the base period, 2005 (0.04 tons)

⁵) SOx emissions reductions are based on 100% recovery capturing the entire NMHC emissions for the base period, 2005 (0.81 tons)

⁶) NOx, CO and PM emissions are estimated using AP-42 Emissions Factors for Flares with clarification from BAAQMD to use 0.01 lb/MMBTU for PM emissions.

The NOx emission factor in AP-42 is 0.068 lb NOx/ MMBTU. This is a higher factor than what is required for use in MRC's refinery emissions permit for FXG combustion (0.05 lb NOx/ MMBTU).

OPTION 2: PROVIDE FLEXIGAS STORAGE.

Regulations in Contra Cost County require consideration of Inherently Safer Systems to proposed process revisions. Key strategies in making things inherently safer include: reducing both the amount of materials stored and their hazard classification, and making use of a simple processing scheme that is not reliant on active controls. Measured against this standard, the proposed active system of compressing, storing and reprocessing fuel gas, as an alternative to immediately flaring these gases, would not be preferred under the Contra Costa County Industrial Safety Ordinance. Regardless, for the purposes of this plan, our analysis considers two storage options. Table 4 summarizes the cost effectiveness calculations for these options. Additional details are provided in Appendix F.

Option 2A consists of a pressurized vessel that would require a compressor with capacity ranging between 1 MMSCFD and 10 MMSCFD. This option is depicted in Figure 18. Flexigas in excess of consumer demand is routed to storage via compressor(s). A controlled flow is returned to the distribution system when enough consumers are available to avoid flaring. Due to the limited capacity of this storage, it has no real capability to accommodate prolonged fuel system imbalances. As a result, the expected best-case emission reductions are about the same as those available in 2005. A rough capital cost for the storage and large compressors is about \$27,000,000²². Annual electrical costs for the required compressors add another \$600,000. The annualized capital plus electrical costs to eliminate a ton of non-methane hydrocarbon result in a cost-effectiveness of approximately \$190 Million dollars per ton. Therefore, Option 2A is even less cost-effective for reducing flaring than Option 1.

Option 2B uses low-pressure expandable gas storage. This option is depicted in Figure 19. This type of storage can be built significantly larger than the pressurized storage used in option 2A, and has the advantage of not requiring compressors in some cases. However, the concentration of carbon monoxide in the gas will likely require use of a water seal to limit leakage, restricting vessel height to a single lift. The requirement for a single lift, combined with low-pressure operation, significantly limits available storage volume²³. In any event, the installed cost is approximately \$21,000,000, providing cost-effectiveness of approximately \$276 Million dollars per ton of NMHC. As was the case for Option 2A, this option is even less cost-effective for reducing flaring than Option 1.

Flaring due to gas quality: Flexigas may be flared during Flexicoker startup and shutdown to avoid poisoning the Flexsorb solution in the early stage of gasification. This is specified in Operating Procedures provided by the technology vendor, Exxon/Mobil, and is addressed in the Flexsorb unit Operating Permit. MRC staff are working with Exxon/Mobil to understand whether it is possible to reduce the volume flared by revising the procedure without poisoning the Flexsorb solution which would result in the inability to treat the flexigas. The permit condition currently allows flexigas flaring for a certain number of hours during startup and shutdown of the Flexicoker. Outside of this condition, Flexigas is not flared as a direct consequence of its quality.

²² Based on a nominal 1 MMSCF sphere (60' diameter) at 120 psig, and two 4 MMSCFD compressors. This system would handle only minor imbalances while the Flexicoker cuts rate.

²³ The actual available storage volume is probably on the order of 1 MMSCFD, and will severely limit achievable emissions reductions. A 50% savings is premised for this analysis.

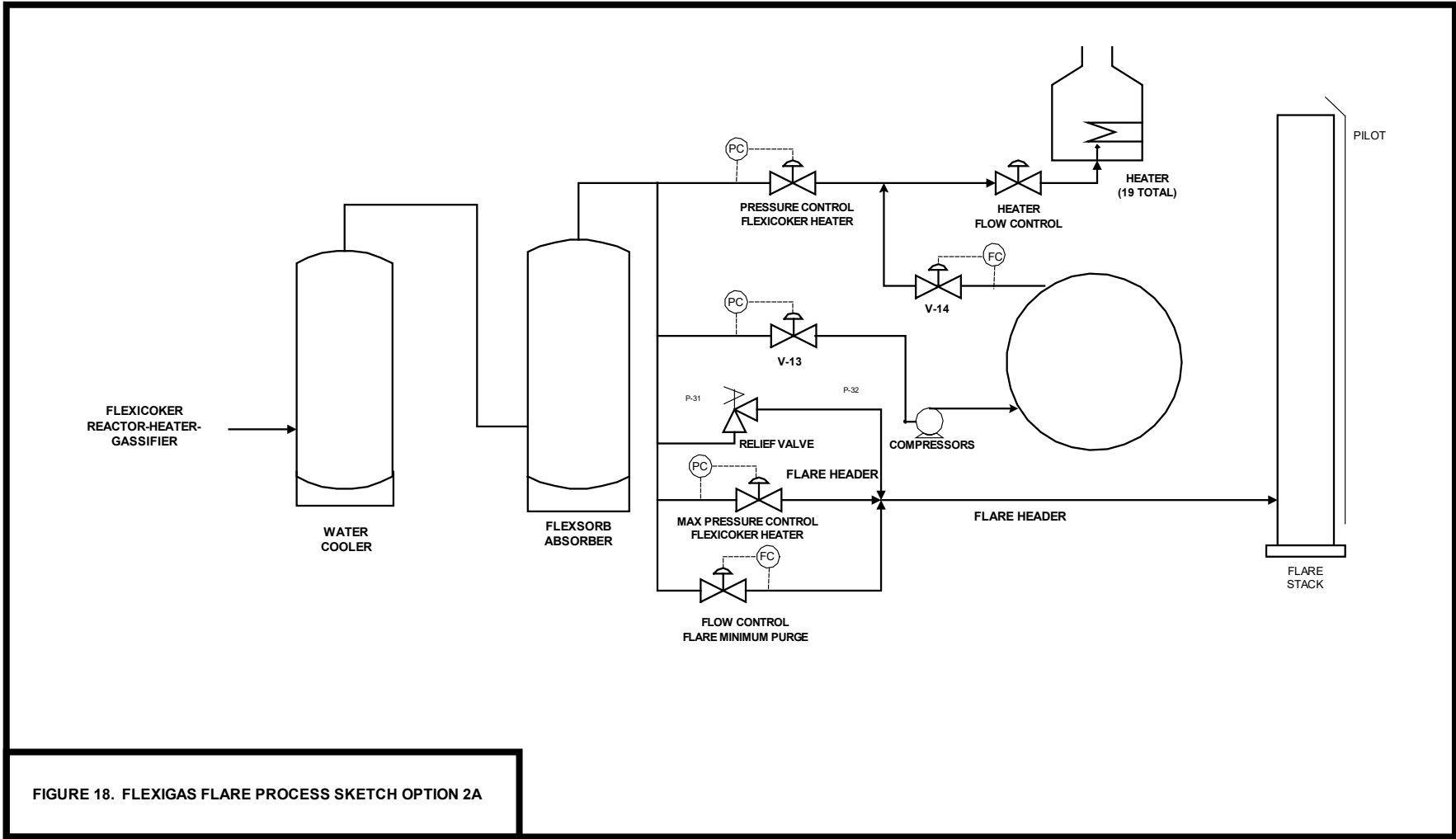

FIGURE 18. FLEXIGAS FLARE PROCESS SKETCH OPTION 2A

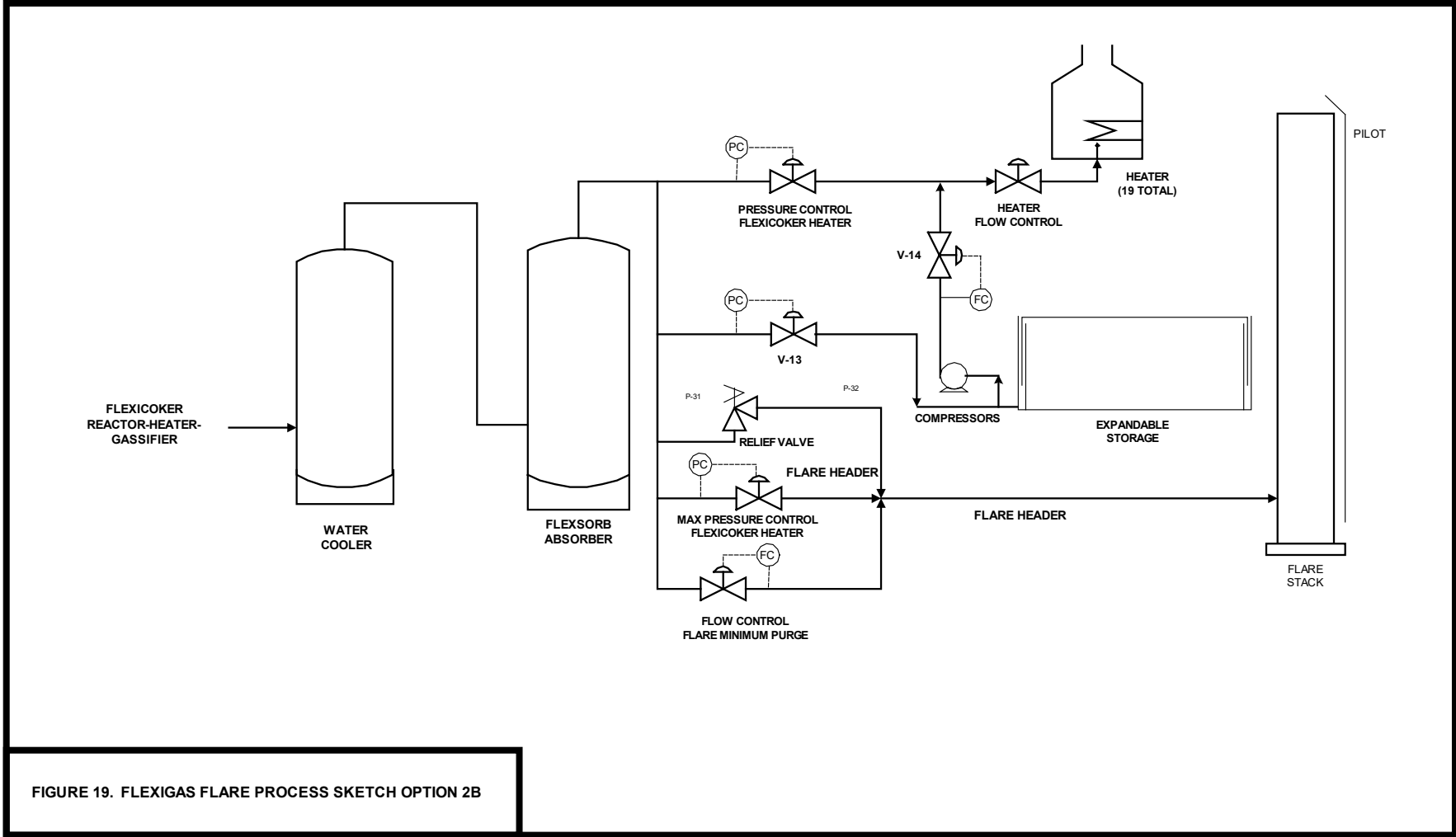

FIGURE 19. FLEXIGAS FLARE PROCESS SKETCH OPTION 2B

Table 4. Economic Justification for Recovery of Flexigas

2A. Pressurized Flexigas Storage

Percent Emission Reduction Expected ¹	Capital Cost	Annual Indirect Cost ²	Annual Direct Cost ³	Combined Annual Cost ^{2,3}	Emissions Reductions by Species					Cost Effectiveness of Reductions (\$ Million/ton)				
					(lbs/year)									
(%)	(\$)	(\$/yr)	(\$/yr)	(\$/yr)	NMHC ⁴	SOx ⁵	NOx ⁶	CO ⁶	PM ⁶	NMHC ⁴	SOx ⁵	NOx	CO	PM
100%	\$3,000,000	\$5,906,000	\$1,695,000	\$7,601,000	80	1,620	39	211	6	\$190	\$9.4	\$391	\$72	\$2,660

¹) Calculations based on Flexigas Flare emissions reported for 2005 assuming 100% reduction

²) Indirect costs include Capital Recovery (10% interest over 10 yr), plus other costs described in the BACT implementation procedure

³) Direct costs include Labor, plus other costs described in the BACT implementation procedure

⁴) Non Methane Hydrocarbon emissions reductions are based on 100% recovery capturing the entire NMHC emissions for the base period, 2005 (0.04 tons)

⁵) SOx emissions reductions are based on 100% recovery capturing the entire NMHC emissions for the base period, 2005 (0.81 tons)

⁶) NOx, CO and PM emissions are estimated using AP-42 Emissions Factors for Flares with clarification from BAAQMD to use 0.01 lb/MMBTU for PM emissions.

The NOx emission factor in AP-42 is 0.068 lb NOx/ MMBTU. This is a higher factor than what is required for use in MRC's refinery emissions permit for FXG combustion (0.05 lb NOx/ MMBTU).

2B. Low Pressure Flexigas Storage

Percent Emission Reduction Expected ¹	Capital Cost	Annual Cost ²	Indirect Annual Direct Cost ³	Combined Annual Cost ^{2,3}	Emissions Reductions by Species					Cost Effectiveness of Reductions (\$ Million/ton)				
					(lbs/year)									
(%)	(\$)	(\$/yr)	(\$/yr)	(\$/yr)	NMHC ⁴	SOx ⁵	NOx ⁶	CO ⁶	PM ⁶	NMHC ⁴	SOx ⁵	NOx	CO	PM
50%	\$21,000,000	\$4,594,000	\$917,000	\$5,511,000	40	810	19	106	3	\$276	\$14	\$567	\$104	\$3,858

¹) Calculations based on Flexigas Flare emissions reported for 2005 assuming 50% reduction

²) Indirect costs include Capital Recovery (10% interest over 10 yr), plus other costs described in the BACT implementation procedure

³) Direct costs include Labor, plus other costs described in the BACT implementation procedure

⁴) Non Methane Hydrocarbon emissions reductions are based on 100% recovery capturing the entire NMHC emissions for the base period, 2005 (0.04 tons)

⁵) SOx emissions reductions are based on 100% recovery capturing the entire NMHC emissions for the base period, 2005 (0.81 tons)

⁶) NOx, CO and PM emissions are estimated using AP-42 Emissions Factors for Flares with clarification from BAAQMD to use 0.01 lb/MMBTU for PM emissions.

The NOx emission factor in AP-42 is 0.068 lb NOx/ MMBTU. This is a higher factor than what is required for use in MRC's refinery emissions permit for FXG combustion (0.05 lb NOx/ MMBTU).

Review of existing vent gas recovery capacity: There is no vent gas recovery or storage capacity for Flexigas. The Flexsorb Unit is designed to be able to treat all Flexigas that can be produced for sulfur removal.

OPCEN Flexigas flare gas recovery system capacity:

Total OPCEN Flexigas flare gas recovery capacity	= 0 MM SCFD
Total OPCEN Flexigas flare gas storage capacity	= 0 SCF
OPCEN Flexigas fuel gas treating capacity	= 250 MM SCFD

401.4.3 Recurrent Failures

There have been no recurrent failures in equipment routed to the OPCEN Flexigas flare in the period since July 2005.

The Appendices have been redacted from the Public Version as they contain Business Confidential Information

APPENDIX A
LOP AREA FLARE TECHNICAL DATA

APPENDIX B
DELAYED COKING AREA FLARE TECHNICAL DATA

APPENDIX C
OPCEN HYDROCARBON FLARE TECHNICAL DATA

APPENDIX D
FLEXIGAS FLARE TECHNICAL DATA

APPENDIX E
REFINERY FUEL GAS SYSTEM

APPENDIX F
DETAILED ECONOMICS FOR FLARE MITIGATION OPTIONS